

# Lung Ablation: Indications and Techniques

Bashir Akhavan Tafti, MD, MBA<sup>1</sup> Scott Genshaft, MD<sup>2</sup> Robert Suh, MD<sup>1,2</sup> Fereidoun Abtin, MD<sup>1,2</sup>

<sup>1</sup> Divisions of Interventional Radiology, David Geffen School of Medicine, UCLA Health System, Los Angeles, California

<sup>2</sup> Thoracic Imaging at the Department of Radiological Sciences, David Geffen School of Medicine, UCLA Health System, Los Angeles, California

Address for correspondence Fereidoun Abtin, MD, Division of Thoracic and Interventional Imaging, Department of Radiological Sciences, David Geffen School of Medicine, UCLA Health System, RRUMC 1621, 757 Westwood Plaza, Los Angeles, CA 90095 (e-mail: fabtin@mednet.ucla.edu).

Semin Intervent Radiol 2019;36:163–175

## Abstract

### Keywords

- ▶ interventional radiology
- ▶ lung
- ▶ lung cancer
- ▶ ablation

Lung ablation is ever more recognized since its initial report and use almost two decades ago. With technological advancements in thermal modalities, particularly microwave ablation and cryoablation, better identification of the cohort of patients who best benefit from ablation, and understanding the role of imaging after ablation, image-guided thermal ablation for primary and secondary pulmonary malignancies is increasingly recognized and accepted as a cogent form of local therapy.

Lung ablation is ever more recognized since its initial report and use almost two decades ago. With technological advancements in thermal modalities, particularly microwave ablation and cryoablation, better identification of the cohort of patients who best benefit from ablation, and understanding the role of imaging after ablation, image-guided thermal ablation for primary and secondary pulmonary malignancies is increasingly recognized and accepted as a cogent form of local therapy.

The role of ablation in lung is primarily focused on the treatment of early-stage primary lung carcinoma especially in the medically inoperable population, oligometastatic and oligorecurrent disease.

Currently, radiofrequency ablation (RFA), MWA, and cryoablation are the thermal energies of choice for lung ablation. Laser ablation, although locally effective,<sup>2</sup> has not gained much traction among users, and irreversible electroporation (IRE) is of limited use in the lung due to its low local control rates.<sup>3,4</sup>

This article will focus on describing the mechanisms and techniques of ablation in the lung, review the current literature on the role of ablation in the management of primary lung carcinoma and metastases to the lung, and finally provide a brief overview of the recommended imaging postablation.

## Mechanism of Ablation and Tissue Injury

Several minimally invasive hyperthermal (e.g., RFA, MWA) and hypothermal (i.e., cryoablation) tissue ablation techni-

ques have been used for targeted treatment of lung and chest wall tumors. While most pulmonary ablation procedures are performed under CT or CT fluoroscopy guidance, ultrasound (in conjunction with CT) has also been used for peripheral parenchymal and chest wall tumors.

The basic mechanism of action in hyperthermal approaches is protein denaturation and subsequent coagulative necrosis by exposing the target tissue to high temperatures, usually above 55°C.<sup>5</sup> In the case of RFA, passage of an approximately 400 kHz electrical current from electrode(s) toward exit grounding pads results in heat generation in tissue mainly at the vicinity of the active electrode(s).<sup>6</sup> Hence, feasibility of RF ablation in any certain organ depends on electrical conductance of the target. In lungs, because of poor electrical conductance of normal tissue as well as its higher impedance compared with malignant lesions, most of the electrical current is diverted to and passes through the tumor. In addition, in contrast to solid tumors, normal pulmonary parenchyma is a poor heat conductor. Therefore, the generated heat gets “trapped” within the tumor margins and spares the surrounding normal parenchyma. Despite certain advantages such as ubiquitous availability of RF-based devices and prolonged clinical experience with these systems, RFA has notable limitations. First, rapid tissue charring on or at close proximity of the electrodes can increase impedance and decrease further application of heat and its conductance, thereby limiting ablation zone size (i.e., suboptimal treatment of tumor periphery). To overcome this problem, electrode modification techniques such as internal

Issue Theme Interventional Oncology: Management of Non-Liver Malignancies; Guest Editor, Thuong G. Van Ha, MD, FSIR

Copyright © 2019 by Thieme Medical Publishers, Inc., 333 Seventh Avenue, New York, NY 10001, USA.  
Tel: +1(212) 584-4662.

DOI <https://doi.org/10.1055/s-0039-1693981>.  
ISSN 0739-9529.

cooling and expanding tines have been established. Another limitation of RFA is incomplete tumor ablation near larger blood vessels and airways due to “heat sink” phenomenon wherein ablation zone temperatures at the periphery of the blood vessel or airway is reduced to sublethal thresholds by the circulating blood and movement of air, respectively. Finally, utilization of electric currents inherent in RFA requires grounding pads exposing the patients to the risk of local burns.

MWA is also based on inducing cell injury using thermal energy.<sup>5</sup> With MWA, heat generation is achieved by oscillation of electromagnetic field between active dipoles at the tip of MW antennas. This causes continuous realignment and agitation of water molecules and increased kinetic energy. In contrast to electric currents, electromagnetic radiation which has much higher frequencies compare with RF is not affected by tissue impedance and hence, larger ablation volumes can be achieved.<sup>7</sup> Currently, two MWA systems using 915 and 2,450 MHz frequencies are available for clinical use. It is hypothesized but questionable that because of higher range of tissue penetration, the 915-MHz system is capable of inducing larger ablation zones.<sup>8</sup> Besides being independent of tissue impedance and generating higher temperatures, MWA has several other advantages including shorter ablation times and relative insensitivity to the “heat sink” phenomenon.<sup>7,9</sup> The latter feature is especially beneficial when treating lesions adjacent to prominent blood vessels as it decreases the potential for residual tumor and local tumor progression. In addition, larger ablation zones generated by each microwave antenna reduce the number of antennas needed to treat large tumors, together with shorter procedure times reduce complications and improve patient experience.<sup>10</sup>

Cryoablation applies lethal subzero Celsius temperatures to the target lesion to induce cellular death and tissue injury through several mechanisms, including protein denaturation, cell membrane rupture due to osmotic shifts, and microvascular thrombosis.<sup>11,12</sup> This is achieved through expansion of a non-ideal gas (argon) through an orifice or other restriction in a closed circuit within the ablation probe via Joule-Thomson effect. The resulting ice ball around the probe is characterized by a gradient of isotherms with central temperatures as low as  $-170^{\circ}\text{C}$  and approaching  $0^{\circ}\text{C}$  in the periphery. Although cell death can occur at temperatures below  $-20^{\circ}\text{C}$ ,<sup>13</sup> a consensus threshold of  $-40^{\circ}\text{C}$  has emerged as the target to achieve complete cell death.<sup>11</sup> Several procedural and anatomic factors including duration of cryoablation, number of freeze-thaw cycles, utilization of accessory warming devices, variations in regional blood flow causing heterogeneous thermal gradients, and tumor-specific response to the freeze-thaw stress can affect lethal isotherms and outcomes of cryoablation.

## Indications

### Lung Cancer

Since its introduction almost two decades ago, percutaneous lung ablation has expanded rapidly and percutaneous tumor ablation is now practiced routinely at many centers around the world. The current body of literature has demonstrated

safety, efficacy, cost-effectiveness, and benefits in overall survival (OS) with acceptable local control.

### Radiofrequency Ablation for Lung Cancer

RFA is the most extensively utilized and studied technique for ablation of primary lung tumors. A recent large meta-analysis comprising a sample size of 1,989 patients with 3,025 lung tumors demonstrated a technical success rate of 96%.<sup>14</sup> The same analysis reported recurrence and local tumor progression rates of 35 and 26%, respectively. Major and minor complications were in 6 and 27% of cases, respectively.<sup>14</sup> Several prospective trials appear in the medical literature, primarily enrolling inoperable stage IA non-small cell lung cancer (NSCLC). One such trial, ACOSOG Z4033, reported OS rates above 86 and 58% at 1 and 3 years, respectively.<sup>15,16</sup> OS was better for patients with tumors less than 2.0 cm in size.<sup>15</sup> Based on these and other such results, RFA is now considered a reasonable alternative treatment option for patients with inoperable lung cancer and the American College of Chest Physicians included RFA in its most recent treatment recommendations for tumors measuring less than 3 cm in size.<sup>17</sup> Further, prospective studies demonstrating 1-, 3-, and 5-year OS rates of 97.7, 72.9, and 55.7%, respectively, have indicated that RFA can be effective in the treatment of recurrent NSCLC after surgical resection.<sup>18</sup> Improved survival rates were seen in patients with tumors less than 3 cm in size and female patients.

### Microwave Ablation for Lung Cancer

Microwave ablation is a more recent technology that was first introduced almost two decades ago. In addition, it is widely reported that MWA produces larger and more homogeneous ablation zones compared with RFA. Nevertheless, several prospective clinical studies including lung microwave radiofrequency randomized trial (LUMIRA)<sup>19</sup> have indicated that the types and incident rates of complications arising from MWA, local progression rates, and survival time following MWA are very similar to those of RFA.<sup>19–21</sup> Speculation as to why long-term survival following MWA is not improved over RFA could be that as operators have gained more experience with minimally invasive tumor ablation techniques, they are now treating more complicated patients with higher comorbidities. Support for the latter claim comes from studies demonstrating significantly higher reduction in tumor mass following MWA.<sup>19,21</sup> Other advantages of MWA over RFA include shorter operation times and less intraprocedural pain.<sup>19,21</sup>

Finally, a recent report comparing 54 patients undergoing MWA to 108 patients undergoing lobectomy for the treatment of stage I NSCLC showed that while complication rates were lower in the MWA group, no significant difference was observed between the two groups in OS, disease-free survival, local tumor progression, or rate of distant metastases. While these findings should not be construed upon as MWA replacing surgical resection, they warrant further randomized trials to evaluate MWA efficacy versus other local therapies.<sup>19</sup>

### Cryoablation for Lung Cancer

Percutaneous pulmonary cryoablation is now practiced widely at many centers around the world with good safety

and efficacy on par with RFA. However, there is less literature on lung cryoablation compared with RFA and MWA. In fact, almost all of the reports available on this technique are based on retrospective single-institution studies and as a result, there is no consensus on optimal ablation parameters such as duration, speed, and number of freeze–thaw cycles. Despite the latter, several advantages of cryoablation such as preservation of collagenous tissue architecture, higher safety profile adjacent to critical structures (e.g., trachea and large vessels), less susceptibility to “heat sink” phenomenon, and eliciting a systemic antitumor response warrant further studies to establish optimized procedural protocols. A recent study reported a good 5-year survival rate up to 67.8% in patients with inoperable stage I NSCLC.<sup>22</sup> The study demonstrated cancer-specific survival rate at 5 years was 56.6%, and the 5-year progression-free survival rate was 87.9%. Most recently, McDevitt et al treated 25 primary lung cancers using cryoablation. Patients with T1 tumors had OS rates at 1 and 3 years of 100 and 63%, respectively. However, the local control rate was 71% at 1 year and 37% at 3 years. Tumors measuring greater than 3 cm were associated with higher risk of local tumor progression, in keeping with RFA data.<sup>23</sup>

### Thermal Ablation versus Other Local Therapies for Lung Cancer

Stereotactic body radiation therapy (SBRT) and sublobar resection are other options used for local control of lung cancer in medically inoperable patients. The institutional data from SBRT are varied, and comparison to ablation is limited. However, a national cancer database analysis comparing RFA to SBRT in early-stage NSCLC was performed on a cohort comprising 4,454 cases of SBRT and 335 cases of RFA. Estimated median survival and follow-up were 38.8 and 42.0 months, respectively. Patients treated with RFA had significantly more comorbidities ( $p < 0.001$ ) and higher risk for an unplanned readmission within 30 days (hazard ratio = 11.536;  $p < 0.001$ ). No difference in OS for the unmatched groups was found on multivariate Cox regression analysis ( $p = 0.285$ ). No difference was found in the matched groups with 1-, 3-, and 5-year OS of 85.5, 54.3, and 31.9%, respectively, in the SBRT group versus 89.3, 52.7, and 27.1%, respectively, in the RFA group ( $p = 0.835$ ).<sup>24</sup>

Combination of ablation and radiation can help improve outcomes. Chan et al reported 17 medically inoperable patients with biopsy-proven stage I NSCLC treated with RFA followed by single fraction high dose rate brachytherapy on the same day. This study was limited to 22 months of follow-up. However, excellent local control was reported in four of seven cases with T2N0 and all nine patients with T1 disease.<sup>25</sup> In another study, 41 patients with inoperable early-stage NSCLC were treated with ablation (RFA = 37 and MWA = 4) followed by standard-fraction external-beam radiation therapy within 90 days ( $n = 27$ ) or postprocedural brachytherapy ( $n = 14$ ). The OS rates were 97.6% at 6 months, 86.8% at 1 year, 70.4% at 2 years, and 57.1% at 3 years.<sup>26</sup>

In medically inoperable patients, surgery carries higher risk and if attempted may be performed with limitations and hence

has demonstrated no survival or local benefit to ablation. Kim et al reported no difference in OS in 22 patients with stage I NSCLC treated with RFA ( $n = 8$ ) versus resection ( $n = 14$ ), although the data are limited due to small sample size in each treatment arm.<sup>27</sup> Kwan et al reported no significant difference in OS and lung cancer-specific survival in patients with early-stage NSCLC treated with ablation versus sublobar resection after patient cohorts underwent propensity score matching. In addition, the same group found patients after matching for OS who underwent ablation had significantly lower treatment-related costs than those who underwent sublobar resection. For patients requiring hospital admission, the average length of stay for cryoablation was 1.6 versus 6 days for sublobar resection.<sup>28</sup> In a novel study, Zemlyak et al reported no difference in OS at 3 years in patients with Stage I NSCLC undergoing sublobar resection ( $n = 25$ ), RFA ( $n = 12$ ), and cryoablation ( $n = 27$ ); again data are limited due to small sample size.<sup>29</sup> In an analysis of the patient characteristics of three completed NCI trials by Crabtree et al, those patients enrolled in the ACOSOG z4033 trial undergoing RFA for stage IA NSCLC were significantly older and had significantly lower diffusion capacities than those patients enrolled in the RTOG 0236 and ACOSOG z4032 trials. Similarly, Kim et al, Lee et al, and Alexander et al showed significant differences in age and pulmonary function in those patients undergoing RFA for primary lung cancer compared with their surgically resected counterparts.<sup>27,30–32</sup> Hence, in this subgroup of patients, ablation may be a viable alternative to resection with similar survival outcome but with lower costs and shorter recovery time.

### Lung Metastasis

RFA, MWA, and cryoablation have also been used in the management of patients with metastatic disease in the lungs. The general rule is that patients with four or less lesions per lung can be managed effectively with percutaneous ablation.<sup>33</sup> Preablation tumor size and location (in relation to hilum) are the most important factors determining the efficacy of the treatment. Specifically, favorable response is more frequently observed in peripheral lesions and tumors with a maximum diameter of 3 cm or less.<sup>34</sup>

In the largest reported series wherein 566 patients with 1,037 metastases were treated with RFA, the authors reported 1- and 5-year OS rates of 92.4 and 51.5%, respectively.<sup>35</sup> Results from other studies performed with MWA and cryoablation compare favorably with those of RFA-based investigations,<sup>33</sup> although findings should be interpreted with caution, as smaller cohorts have been treated. Single- and multi-institutional data report 5-year OS in oligometastatic patients undergoing RFA between 13 and 69% with colon carcinoma patients with better reported outcomes in long-term OS.<sup>36–39</sup> The latest of such investigations is the ongoing multicenter prospective Evaluating Cryoablation of Metastatic Lung/Pleura Tumors in Patients—Safety and Efficacy (ECLIPSE) trial wherein 40 patients with 60 pulmonary lesions from colon, renal, and sarcoma primaries are included. Preliminary results of the latter study have shown 1-year OS and local control rates of 97.5 and 94.2%, respectively.

## Technical Consideration for Lung Ablation

### Position during Ablation

Positioning the patient on CT scanner and maintaining the position throughout lung ablation is essential in targeting the tumor. Considerations when planning the patient's position include use of local or general anesthesia, the patient's ability to lie in a particular position, location of the nodule, presence of fissures, and needle trajectory along bronchovascular bundle. In general, lateral decubitus and lateral approach should be avoided as it is associated with region of<sup>35</sup> increased rib movement and higher chances of pneumothorax (PTX). Additionally, when patient is in lateral decubitus position, the nontargeted lung is subject to decreased volume and collapse and hence increased ventilation through targeted nondependent lung, which then leads to increased risk of PTX and decreased accuracy in targeting the tumor (►Fig. 1). Prone is a preferred position to supine, as it limits movement, limits interaction with sedated but conscious patient, and allows for easier recovery.

### Sedation and Anesthesia

Local anesthesia at skin, along needle track and parietal pleura, is achieved in all patients, irrespective of use of general anesthesia (GA) or conscious sedation. A 19-gauge coaxial introducer needle can be used to achieve effective pleural anesthesia by placing the needle tip just deep to the endothoracic fascia where 10 to 15 mL of local anesthetic is delivered. This needle also serves to guide the trajectory of ablation probe and in case of PTX can be used to drain the PTX during procedure. Lidocaine 0.5 to 1% is used regularly and for prolonged anesthesia in particular at pleura, bupivacaine 0.5% is preferred. The choice of anesthesia is mostly user dependent, but many centers prefer using GA during the procedures. This may be habitual as other organ ablations are performed under GA. Advantages of GA are the presence of

cardiopulmonary support while performing the procedure, especially in a cohort of patients which are older and limited in cardiopulmonary reserve.<sup>31</sup> In a phase 2 multicenter study comprising 40 patients with 60 metastases who underwent cryoablation, 67% underwent GA, 31% used moderate sedation, and the remaining 2% used regional anesthesia.<sup>40</sup> Other advantages of GA include better pain management during ablation and recovery. The use of conscious sedation allows for shorter procedural setup, better control of breath hold, lower cost, and quicker recovery.

### Ablation Technique

The principal of placing ablation needles is mostly same between the modalities, but nuances exist for each technique in an effort to complete ablation cycles and avoid complications.

Nodules present in periphery of the lung are best approached via a tangential approach. This allows for the ablation needle to traverse adequately through lung parenchyma, better targeting of the tumor and avoiding back burn or freeze along ablation track to pleura and chest wall. When using MWA, this tangential approach helps avoid back burn along the microwave antenna to the visceral pleura and potential bronchopleural fistula (BPF; ►Figs. 2 and 3) and with cryoablation it helps contain parenchymal hemorrhage and avoid a track for pulmonary bleed to leak into pleura and subsequent hemothorax (►Fig. 4). For central tumors, an approach parallel to bronchovascular bundle is preferred, but the approach should also consider the essential technical need to extend the needle tip beyond the tumor margins. Lung volume is subject to change during respiration and through the course of ablation, the lung volume continues to reduce, in part from sedation; hence, it is important to anticipate this change in volume while planning ablation, as the needle tip may migrate and finally terminate closer to vital vessels or heart and lead to complications. Fissures are bilayers of pleura and hence traversing the fissures increases the rates of PTX which can delay or limit the procedure.

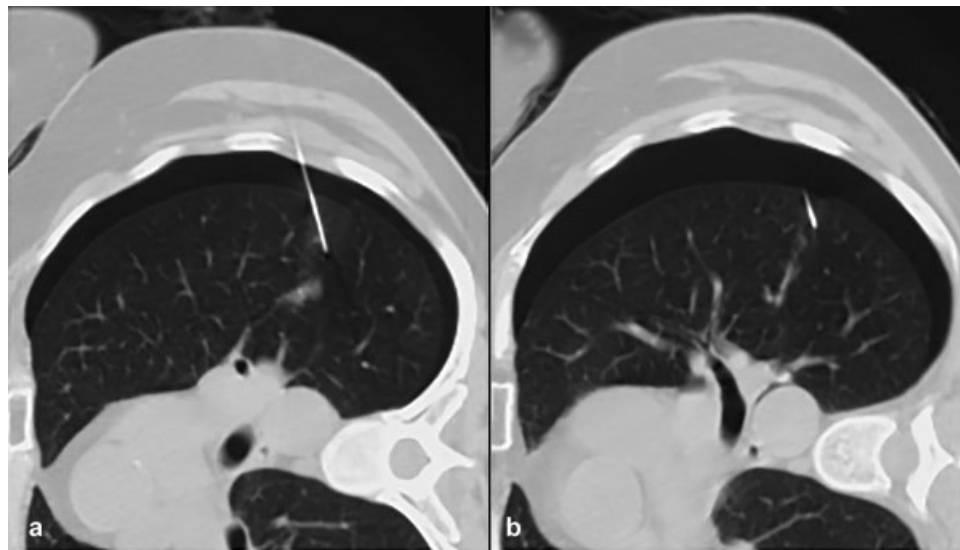

**Fig. 1** (a) Suboptimal lateral approach for biopsy of lung nodule. Respiratory motion and rib cage movement increases the rate of pneumothorax and targeting the tumor difficult. (b) With increasing pneumothorax, there is displacement of needle out of lung and change in approach and trajectory.

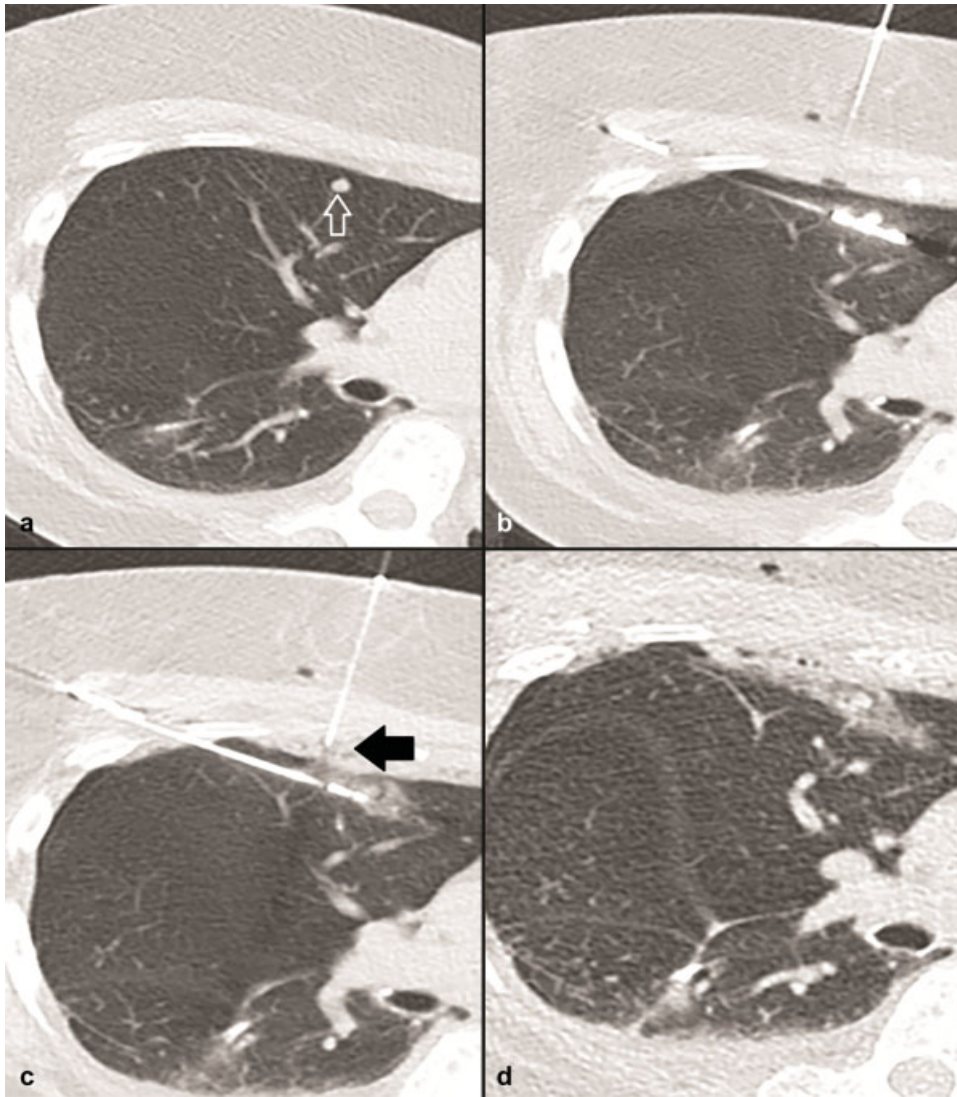

**Fig. 2** (a) Inferior vena cava leiomyosarcoma with metastasis to periphery of right upper lobe (arrow). (b) Microwave ablation antenna was placed via tangential approach to avoid back burn into the pleura. (c) Coaxial needle was placed from different approach for pleural anesthesia and to provide insulation and intercostal nerve protection (arrow). Note the extent of pleural anesthesia injected is ~10 mL of lidocaine. (d) Postablation demonstrates ablation zone with no bronchopleural fistula.



**Fig. 3** (a) Lung carcinoma in the right middle lobe (arrow). (b) Microwave ablation antenna was placed in the tumor via direct approach with the shaft less than 3 cm in lung parenchyma. (c) Postablation there was an ablation tract extending from lung into pleural space with potential bronchopleural fistula (BPF). A tangential approach as demonstrated in ► Fig. 2 would be preferred to avoid this BPF.

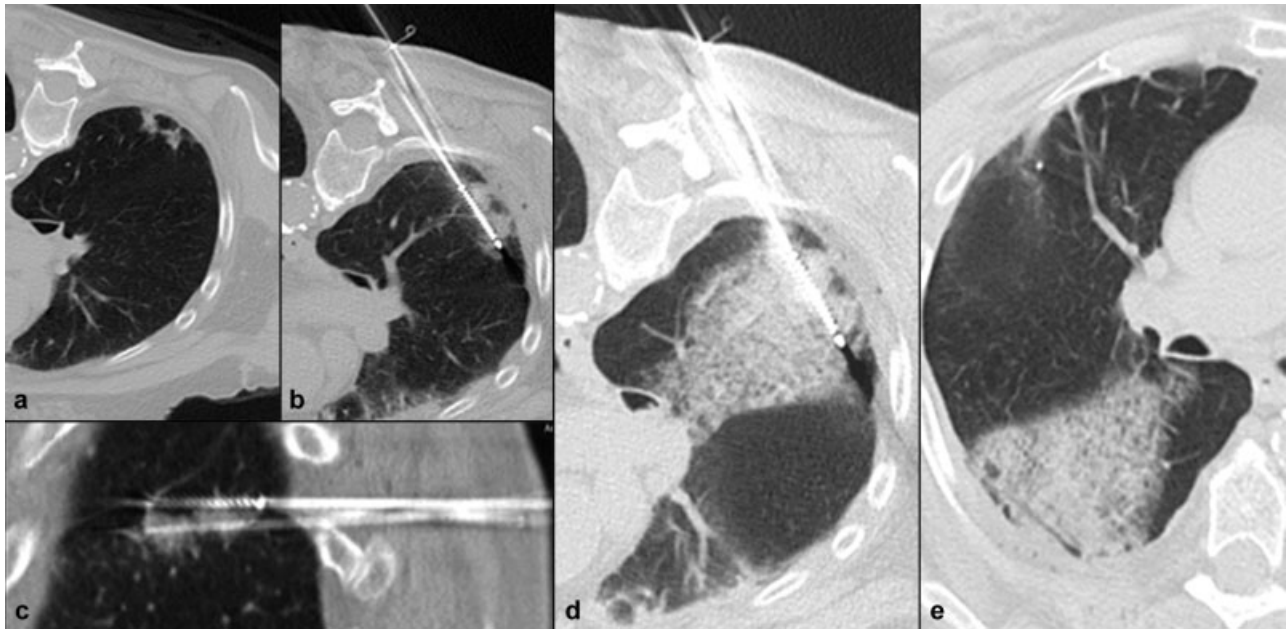

**Fig. 4** (a) Primary lung carcinoma in superior segment of right lower lobe. (b, c) Axial and coronal images demonstrate two cryoablation probes placed in a tangential approach along length of the tumor to allow for better coverage, better steering, and for the probe to be well within lung tissue to avoid the ice ball from extending into the pleura along the probe shaft. (d) Following third cycle of ablation using 3 F, 3 PT, 7 F, 3 PT, and 10 F cycles. The bleeding is confined to the lobe. (e) To avoid spillage of thawed tumor and hemorrhage into rest of lung via transbronchial spillage, probes are removed and patient is turned to keep the ablation zone dependent. Bleeding is usually contained within the lobe.

Fortunately, many fissures are incomplete which can be considered at individual basis when planning for ablation.<sup>41</sup>

RFA systems use single, cluster, or multi-tined electrodes. Cluster electrodes are placed to ablate larger nodules. Placement of these cluster electrodes can be difficult, as the needles may converge close to the target lesion and hence difficult to puncture the target nodule or can displace the nodule in the lung. Same problem is faced with tined electrodes, as they can displace the tumor rather than puncturing the lesions. A trend toward using MWA instead of cluster or tined electrodes for large tumors is present.

MWA systems use single or multiple antennas. Since the energy deposited by these antennas is limited beyond the tip, it is required to extend the tip beyond the tumor margins. This can become a limiting factor when there is limited space beyond the tumor. As mentioned, preplanning and patient positioning can mostly overcome this limitation.

Location of the tumor has direct influence on ablation parameters and power. In a study by Al-Hakim et al, lung perfusion and ventilation, postulated based on the lobe and central to peripheral location, had an impact on ablation zone at 1 to 3 months with significantly smaller ablation zones in regions with higher ablation resistance score ( $p < 0.05$ ), a factor which should be considered while selecting the ablation parameters.<sup>42</sup>

Cryoablation systems allow for use of multiple probes. At times it may be difficult to puncture the nodules, especially subcentimeter nodules with cryoprobes and hence bracketing the tumor could be a better choice and should be preplanned. Once the probes are in place, cryoablation is performed using multiple freeze (F) and thaw (T) cycles. Over years various version of freeze and thaw cycles have emerged with the principal being essentially the same. Since lung is not a good

conductor of ice due to limited water per unit volume and low thermal conductivity of aerated lung, a medium needs to be generated for ice to propagate and surround target tumor.<sup>43</sup> It is also important to surround the tumor with isotherm of  $-40^{\circ}$  C. To achieve this, Hinshaw et al reported that using three freeze-thaw cycles led to a larger ablation zone with expanded cytotoxic isotherms.<sup>44</sup> Due to the hemorrhage and hemoptysis associated with prolonged thaws, Pan et al modified the triple freeze cycle to limit the thaw cycles to only 3 minutes and to use passive thaw (PT) achieved by simply not running the helium gas.<sup>45</sup> This modified triple freeze includes 3F-3PT-7F-3PT-10F, which when compared with conventional double freeze demonstrated significantly smaller volumes of pulmonary hemorrhage. At the end of cryoablation, an active thaw cycle is initiated to allow for removal of the cryoprobes. Following completion of ablation, the cryozone undergoes thaw which can lead to hemorrhage and release of intra- and extracellular fluid. This combination can spill into airways and lead to airway occlusion and significant hypoxia. It is recommended to avoid this spillage which can be simply achieved by turning the patient such that the cryozone is dependent and containing the hemorrhage (**Fig. 4**).

### Choice of Ablation Modality

The choice of ablative modality in the lung can be dependent on many factors including the size, location, histopathology of tumor, and comorbidities, which are summarized in **Table 1**. This table grades ablation modalities on multiple parameters and can be used as an adjunct on choosing the ablative energy.

Cryoablation has certain advantages compared with heat-based modalities. It preserves the collagenous architecture of

**Table 1** Comparing ablative technologies

| Parameter(s)             | Radiofrequency | Microwave          | Cryoablation |
|--------------------------|----------------|--------------------|--------------|
| Set up                   | ++             | +++ (quickest)     | +            |
| Duration of ablation     | ++             | +++ (shortest)     | +            |
| ≤3 cm                    | +++            | +++                | +++          |
| >3 cm                    | +*             | ++ + *             | ++*          |
| ≤1.5 cm pleura           | + (pain)       | + (pain, air leak) | +++          |
| Emphysema                | ++             | +++                | +            |
| Chest wall               | +              | ++                 | +++          |
| Mediastinum              | +              | +                  | ++           |
| Thermal sinks            | +              | +++ (least)        | ++           |
| Preservation of collagen | +              | +                  | +++          |
| Coagulopathies           | +++            | +++                | +            |

Source: Adapted from Sharma A, Abtin F, Shepard J. Image-guided ablative therapies for lung cancer. *Radiol Clin N Am* 2012;50(5):975–999.  
\*The ablation volume can change with increasing number of antennae or probes.

the tissue being ablated<sup>46</sup> and hence, can be used at pleura and chest wall and for peripheral lesions as well as structures like trachea, airways, aorta, and other large vessels. This advantage was utilized for cryoablation in recurrent malignant mesothelioma and thymoma after surgery with limited local complications of 7.3 and 8%, respectively.<sup>47,48</sup> Furthermore, the ablation zone appears as a sharply demarcated, low-attenuation ice ball on CT, which allows for near real-time monitoring of the procedure. Another and perhaps one of the most interesting effects and foreseeable advantage of cryoablation is induction of a systemic antitumor immune response by release of significant quantities of tumor-specific antigens from the damaged tissue.<sup>49</sup> In tumors close to the heart and pericardium or large airways, cryoablation is a better choice given its ability to preserve the collagen matrix (► **Fig. 5**); however, MWA has been shown to be safe. Cryoablation comes with limitations of its own; for instance, it is limited by setup and management of the gas supply as system tanks should contain adequate pressurized gas at all times and currently there is dire shortage of helium gas. The setup also takes longer than MWA or RFA. Because small pulmonary nodules cannot be penetrated with most available cryoprobes and the relatively small size of the  $-40^{\circ}\text{C}$  isotherm, two probes are often utilized to bracket tumors greater than 1 cm in diameter. In patients with coagulopathies and in patients with severe emphysema where the lung tissue may not be able to adequately tamponade bleeding, cryoablation is not a preferred method, as bleeding and hemoptysis is a known complication.<sup>50,51</sup> In tumors close to large vessels, complete ablation may be hampered by cold sink effect; hence, MWA may be a preferred choice, although cryoprobes can be safely positioned adjacent to the anticipated vascular sink.

The choice between RFA and MWA is less obvious. RFA benefits from longer user experience, availability, and cumulative literature. Many of MWA users see MW as an improved RFA technique given that both cause cell injury by heat, but as described earlier the mechanism of tissue injury is different

with MWA reaching higher temperatures and less heat sink close to larger vessels. In a study by Shi et al, 75 patients underwent 43 RFA and 32 MWA with no significant difference between the response rates ( $p = 0.309$ ), OS ( $p = 0.653$ ), and complications rates ( $p = 0.921$ ).<sup>52</sup> However, Vogl et al demonstrated statistically significant higher local recurrence rate with RFA after ablation of colorectal metastasis to lung when MWA was compared with RFA at 6 months ( $p = 0.004$ ) and 18 months ( $p = 0.01$ ) postablation.<sup>53</sup> The LUMIRA randomized patients to receive lung RFA or MWA, showing no significant differences between the two groups in terms of survival time ( $p = 0.883$ ), while the pain level in MWA group was significantly less than in RFA group ( $1.79 < 3.25$ ,  $p = 0.0043$ ).<sup>19</sup> It is of note that in LUMIRA trial although the size of primary tumor was not statistically different, the MWA cohort had larger tumors ( $2.21 \pm 0.89$  cm) compared with RFA group ( $1.64 \pm 0.80$ ).<sup>50</sup> The size of the tumor can be the primary factor in deciding between using RFA and MWA. As demonstrated by an earlier publication by Simon et al, using RFA, lung tumors  $\geq 3$  cm had significantly lower ( $p < 0.002$ ) progression-free interval.<sup>36</sup> MWA systems with multiple antennae can reach ablation zones of  $54.8 \pm 8.5$  mm and hence preferred in larger tumors.<sup>54</sup>

Finally, MWA appears to be safer than RFA when used in patients with implantable cardiac devices.<sup>55</sup>

► **Fig. 6** illustrates the location and relative size of tumors and preferred modality.

### Recovery

Following ablation, patients are recovered in observation units for approximately 3 to 5 hours. A single dose of intravenous (IV) acetaminophen (1,000 mg) or IV ketorolac tromethamine (60 mg) adjusted for weight can help alleviate pain postablation and comfortable recovery without side effects of sedation. Patients are followed up with chest radiographs (CXR) to assess for PTX and other complications like pleural effusion and hemorrhage.

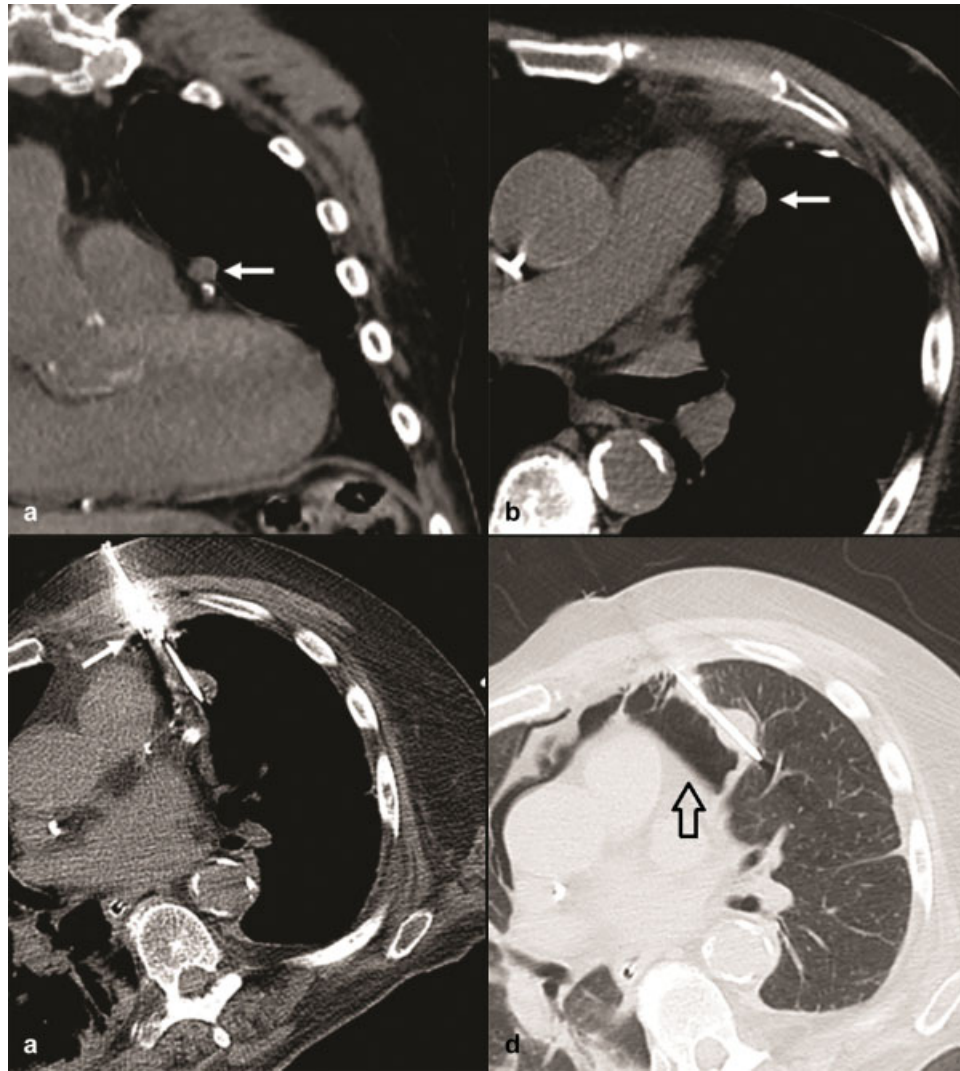

**Fig. 5** (a, b) Recurrent mesothelioma after pleurectomy with the recurrence (arrow) in close proximity of atherosclerotic left anterior descending (LAD). (c) A coaxial needle was placed in the mediastinum to provide track anesthesia, and mediastinal access to induce pneumomediastinum (arrow). Cryoablation probe was placed into the tumor. (d) Up to 50 mL of air was injected (arrow) which allowed for separation of tumor from LAD and successful, uneventful ablation.

Upon discharged, patients are asked to strictly maintain anti-inflammatory medication for 5 to 7 days to avoid onset of stubborn pleuritis. Narcotics can be given for breakthrough pain.

Most patients are discharged on the same day, although some patients need admission and overnight observation. Many factors can affect the decision for prolonged observation and include limited lung or cardiovascular reserve, older patients with limited support at home, or complicated ablation.

### Complications and Management

Common complications from lung ablation include PTX and pleural effusion or hemorrhage,<sup>56</sup> the latter is more common with cryoablation.<sup>57</sup> Other less common complications include nerve injury, aseptic pleuritis, pneumonia, lung abscess, bleeding needing transfusions, BPF, and rarely death.<sup>58</sup>

PTX is the most common complication after ablation, and occurs more with heat-based ablations with the rate ranging

from 1.3 to 60%.<sup>59</sup> PTX can be seen intraprocedure or post-procedure in recovery. ▶**Fig. 7** reviews approach to PTX. When PTX occurs during the procedure and is increasing, early drainage and placement of chest tube are suggested. For ablation probes to be advanced, the lung needs to maintain its compliance and hence a collapsing lung will not allow the probe to be advanced into tumor accurately or safely. Before placing the chest tube, it is possible to just advance the coaxial needle used for local and pleural anesthesia, and inset it into pleural space to aspirate the PTX. This is a temporary measure and can be used only to assess the rate of PTX. If the plan is to drain air with coaxial needle, please ensure that the needle has blunt edge and not a beveled sharp edge, as the latter can further injure the lung. New needles with spring tips are currently being introduced which can be used for drainage of PTX safely. If the air leak continues, this pleural access can be used and converted to a chest tube.

The chest tube should be connected to suction to allow for the lung to reexpand and maintain its compliance, which in





**Fig. 6** Locations that may be preferable for one technology over another. Radiofrequency ablation (orange) is preferred for tumors less than 3 cm and in the center of the lung with limited heat sink. Microwave ablation (red) is preferred for tumors smaller than 3 cm, but can be used for tumors larger than 3 cm and can be used near vessels to avoid heat sink. Cryotherapy (blue) is preferred in periphery of the lung, chest wall, bone, and close to large airways.

turn allows for continuation of the procedure, and path to completion. Chest tube should be left behind and managed postprocedure in recovery unit.

In recovery, a trial of clamping the chest tube after the first CXR can determine if the air leak continues and how fast is the air leak. Following clamping, another CXR can be obtained in 1 hour. If the leak has stopped or is small and patient is stable, patient can be discharged with chest tube connected to Heimlich valve. Many such valves exist, but the valves with containers are preferred to limit spillage of pleural fluid on to patient.

For expanding PTX occurring after the procedure in recovery and expanding, a chest tube should be placed sooner than later. For gradually expanding PTX, chest tube can be placed to suction at  $-20$  cm  $H_2O$  to keep the lung from collapsing. Clamp trial of the tube can be performed. If the air leak has stopped or slowed down, then patient can be discharged with chest tube attached to Heimlich valve. However, if air leak continues, then patient should be admitted. For rapidly expanding PTX or symptomatic PTX, the chest tube should be maintained at  $-40$  cm  $H_2O$  and patient should be admitted.

Chest tube should be placed in nondependent pleural space anteriorly to allow for adequate drainage of air. Air leak should resolve in 48 hours and air leak can be tested by clamping the chest tube and observing for development of PTX. If the air leak continues for 48 hours, possibility of BPF is to be anticipated and active intervention to stop the leak is warranted sooner than later.<sup>60</sup> The options to treat BPF include prolonged chest tube, endoscopic embolization of airways or endobronchial valves, and pleurodesis.<sup>61</sup> Unlike surgical or postinfectious BPF, postablation BPF is from a known locus at the previous needle

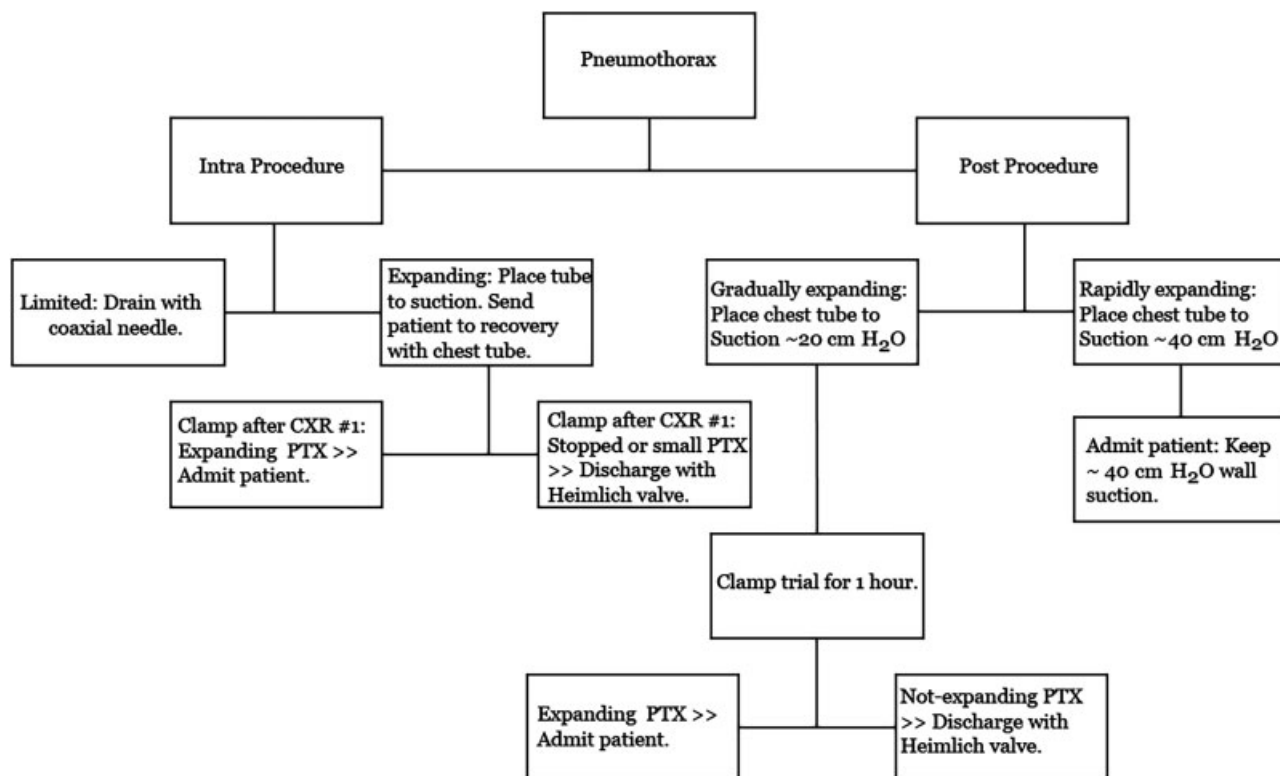

**Fig. 7** Approach to the management of pneumothorax intra or postablation. CXR, chest radiograph; PTX, pneumothorax.

insertion site or ensuing ablation zone which may have been cavitated, which can be helpful in planning localized pleural plugging using a blood patch and glue. There is no evidence to support one agent over another, but glue injection is a quick way of blocking BPF.<sup>62</sup> The procedure is done under CT guidance, patient should be positioned such that the BPF is nondependent, then a needle is placed at the site of BPF, and surgical glue or Gelfoam can be injected at this site. The amount varies, but 3 to 5 mL is usually adequate (► Fig. 8).

Pleural effusion and hemorrhage are next most common complications and can range from 11.6 to 18.8%.<sup>63</sup> Not all

effusions need chest tube insertion and rate of minor self-limited effusion can be as high as 20.7% and less than 3% of patients need chest tube.<sup>56,64</sup> Factors that can contribute to the development of effusion include decreased distance to the nearest pleura, and decreased length of the aerated lung traversed by the electrode.

### Interventional Oncology Clinic

One of the most striking changes to the practice of interventional radiology over the past decade has been the transition

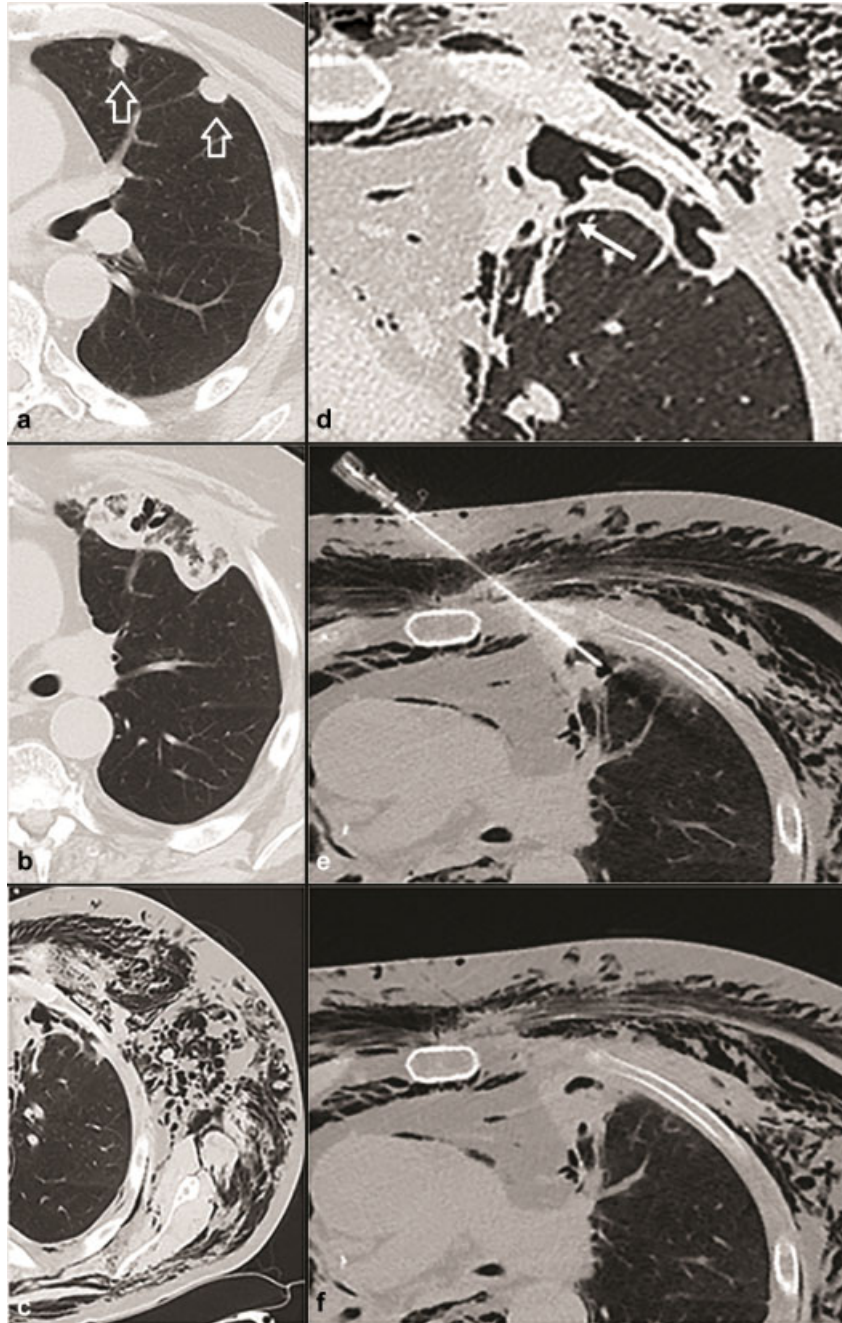

**Fig. 8** (a) Colorectal metastasis to left upper lobe (arrows). (b) One month postcryoablation of both tumors simultaneously. Postablation zone as anticipated. (c, d) Patient presented with extensive pneumomediastinum and subcutaneous emphysema. High-resolution CT scan shows a bronchopleural fistula. (e) Coaxial needle was placed at the level of bronchopleural fistula (BPF) and 2 mL over 15 seconds COSEAL (biocompatible polyethylene glycol polymer) was injected. This polymer rapidly cross-links with proteins in tissue to immediately adhere. (f) Postprocedure CT scan demonstrates occlusion of the BPF.

from an order-based on-demand procedure service to a full clinical service focused on longitudinal management of patients. This is particularly important in the field of interventional oncology, in which decisions on how to treat a patient with minimally invasive image-guided techniques are based on combination of the clinical assessment of the interventional radiologist (IR) along with the medical and surgical oncology treatment plan. To facilitate appropriate treatment, office-based consultation has become standard practice for patients being considered for therapeutic interventional procedures.

The clinical assessment for patients being considered for thermal ablation of lung tumors begins with the clinical presentation. In general, many patients with primary lung cancer and limited-volume metastatic disease to the lungs can be considered for thermal ablation. As a part of the clinical consultation for patients with primary lung cancer, it is incumbent upon the IR to review the patient's medical records and imaging to ensure that the patient is an appropriate candidate. Complete staging as per the standards of the institution, usually PET/CT scan, should be performed prior to intervention, as local therapy as a standalone treatment is appropriate only for early-stage lung cancer. Some patient factors do inform decisions on modality for treatment, whether heat-based ablation or cryoablation, and should be reviewed at the initial clinic visit. Finally, it is advisable that a discussion of alternatives to ablation be discussed with the patient, including surgical resection and radiation, which requires the IR to have some degree of knowledge of these options. As in all local treatments for lung cancer, the intent is for eradication of disease.

A decision to treat a patient with oligometastatic disease to the lungs is typically made jointly with a patient's medical oncologist. As previously discussed, local treatment of some tumor subtypes when in limited number has been shown to

provide survival benefit. The initial clinical visit allows for not only a discussion of the role of local therapy in the patient's disease, but also the opportunity to review the patient's medical management to plan for the ablation during an appropriate time in the chemotherapy treatment cycle.

The timing for clinical follow-up is best determined by the IR, and should include an appropriate review of imaging. In the early period following ablation, imaging is focused on assessment of complications. In our practice, all patients are seen within the first week following ablation and have a PA and lateral CXR performed, to evaluate for PTX or pleural effusion. The initial cross-sectional study obtained following therapy is at 1 month; in general, chest CT is appropriate to evaluate the ablation zone itself.<sup>65</sup> This study serves as a baseline for future imaging studies. Subsequent imaging in the first year is obtained every 3 months, typically a combination of interval contrast-enhanced chest CT and whole-body CT or PET/CT, which are used to assess for local and remote disease recurrence, respectively (→ Fig. 9). Imaging is best obtained on the same day as clinical follow-up, so that a complete oncological assessment can be provided to the patient during the office visit, along with any adjustments of the treatment plan.

## Conclusion

Lung ablation has had natural progression with optimizing modality and technique. Through these advances, it has proven as a viable alternative to other local therapies including radiation and sub lobar resection for management of lung cancer and metastasis. Interventional Oncologists should be familiar with nature of the disease, trained and accustomed in performing these procedures in the lung, and finally manage their patients via interventional oncology practice.

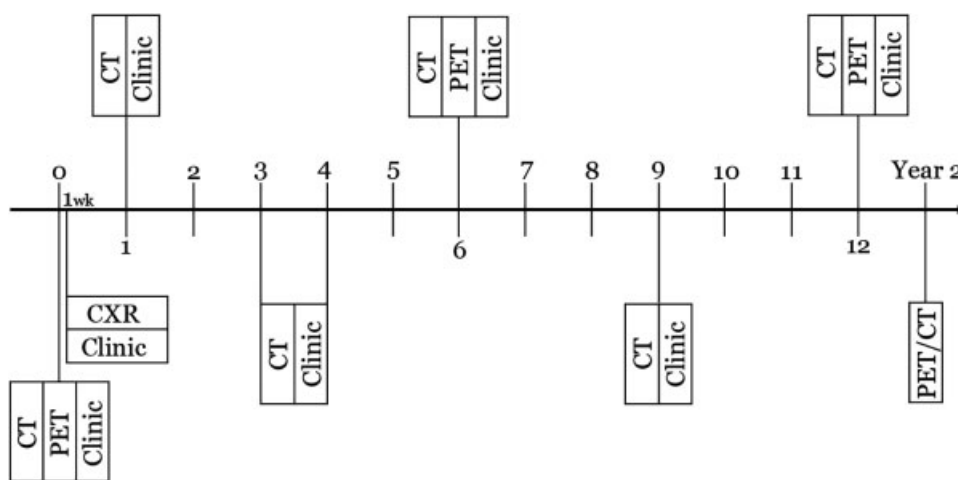

**Fig. 9** Follow-up schema (by month postprocedure) for ablation patient during 1st year and thereafter. A baseline PET/CT is preferred to confirm extent of thoracic and extrathoracic disease. This scan should be reviewed along with IO consult. Postablation at 1 week; CXR with IO clinic visit to evaluate for late complications and follow-up planning. Postablation at 1 month; chest CT with IO clinic visit. This scan is used as baseline for imaging follow-up and response evaluation. Postablation at 3 and 9 months; chest CT with IO clinic visit. Postablation at every 6 months for 24 months; PET/CT with IO consult. After 24 months, the frequency can be increased to every 12 months. If PET/CT is not possible, chest and abdominal scan can be obtained. CXR, chest radiograph; IO, interventional oncology; PET/CT, positron emission tomography/computed tomography.

## Conflict of Interest

None declared.

## References

- Dupuy DE, Zagoria RJ, Akerley W, Mayo-Smith WW, Kavanagh PV, Safran H. Percutaneous radiofrequency ablation of malignancies in the lung. *AJR Am J Roentgenol* 2000;174(01):57-59
- Rosenberg C, Puls R, Hegenscheid K, et al. Laser ablation of metastatic lesions of the lung: long-term outcome. *AJR Am J Roentgenol* 2009;192(03):785-792
- Usman M, Moore W, Talati R, Watkins K, Bilfinger TV. Irreversible electroporation of lung neoplasm: a case series. *Med Sci Monit* 2012;18(06):CS43-CS47
- Ricke J, Jürgens JH, Deschamps F, et al. Irreversible electroporation (IRE) fails to demonstrate efficacy in a prospective multicenter phase II trial on lung malignancies: the ALICE trial. *Cardiovasc Intervent Radiol* 2015;38(02):401-408
- Wright AS, Sampson LA, Warner TF, Mahvi DM, Lee FT Jr. Radiofrequency versus microwave ablation in a hepatic porcine model. *Radiology* 2005;236(01):132-139
- Hong K, Georgiades C. Radiofrequency ablation: mechanism of action and devices. *J Vasc Interv Radiol* 2010;21(8, Suppl):S179-S186
- Brace CL. Radiofrequency and microwave ablation of the liver, lung, kidney, and bone: what are the differences? *Curr Probl Diagn Radiol* 2009;38(03):135-143
- Sun Y, Wang Y, Ni X, et al. Comparison of ablation zone between 915- and 2,450-MHz cooled-shaft microwave antenna: results in vivo porcine livers. *AJR Am J Roentgenol* 2009;192(02):511-514
- Lubner MG, Brace CL, Hinshaw JL, Lee FT Jr. Microwave tumor ablation: mechanism of action, clinical results, and devices. *J Vasc Interv Radiol* 2010;21(8, Suppl):S192-S203
- Hinshaw JL, Lubner MG, Ziemlewicz TJ, Lee FT Jr, Brace CL. Percutaneous tumor ablation tools: microwave, radiofrequency, or cryoablation—what should you use and why? *Radiographics* 2014;34(05):1344-1362
- Gage AA, Baust J. Mechanisms of tissue injury in cryosurgery. *Cryobiology* 1998;37(03):171-186
- Baust JG, Gage AA. Progress toward optimization of cryosurgery. *Technol Cancer Res Treat* 2004;3(02):95-101
- Cooper IS. Cryobiology as viewed by the surgeon. *Cryobiology* 1964;51:44-51
- Li G, Xue M, Chen W, Yi S. Efficacy and safety of radiofrequency ablation for lung cancers: a systematic review and meta-analysis. *Eur J Radiol* 2018;100:92-98
- Dupuy DE, Fernando HC, Hillman S, et al. Radiofrequency ablation of stage IA non-small cell lung cancer in medically inoperable patients: results from the American College of Surgeons Oncology Group Z4033 (Alliance) trial. *Cancer* 2015;121(19):3491-3498
- Palussière J, Chomy F, Savina M, et al. Radiofrequency ablation of stage IA non-small cell lung cancer in patients ineligible for surgery: results of a prospective multicenter phase II trial. *J Cardiothorac Surg* 2018;13(01):91
- Howington JA, Blum MG, Chang AC, Balekian AA, Murthy SC. Treatment of stage I and II non-small cell lung cancer: diagnosis and management of lung cancer, 3rd ed: American College of Chest Physicians evidence-based clinical practice guidelines. *Chest* 2013;143(5, Suppl):e278S-e313S
- Kodama H, Yamakado K, Takaki H, et al. Lung radiofrequency ablation for the treatment of unresectable recurrent non-small-cell lung cancer after surgical intervention. *Cardiovasc Intervent Radiol* 2012;35(03):563-569
- Macchi M, Belfiore MP, Floridi C, et al. Radiofrequency versus microwave ablation for treatment of the lung tumours: LUMIRA (lung microwave radiofrequency) randomized trial. *Med Oncol* 2017;34(05):96
- Vogl TJ, Nour-Eldin NA, Albrecht MH, et al. Thermal ablation of lung tumors: focus on microwave ablation. *RoFo Fortschr Geb Rontgenstr Nuklearmed* 2017;189(09):828-843
- Tsakok MT, Jones D, MacNeill A, Gleeson FV. Is microwave ablation more effective than radiofrequency ablation in achieving local control for primary pulmonary malignancy? *Interact Cardiovasc Thorac Surg* 2019;ivz044
- Moore W, Talati R, Bhattacharji P, Bilfinger T. Five-year survival after cryoablation of stage I non-small cell lung cancer in medically inoperable patients. *J Vasc Interv Radiol* 2015;26(03):312-319
- McDevitt JL, Mouli SK, Nemcek AA, Lewandowski RJ, Salem R, Sato KT. Percutaneous cryoablation for the treatment of primary and metastatic lung tumors: identification of risk factors for recurrence and major complications. *J Vasc Interv Radiol* 2016;27(09):1371-1379
- Lam A, Yoshida EJ, Bui K, Fernando D, Nelson K, Abi-Jaoudeh N. A national cancer database analysis of radiofrequency ablation versus stereotactic body radiotherapy in early-stage non-small cell lung cancer. *J Vasc Interv Radiol* 2018;29(09):1211-1217.e1
- Chan MD, Dupuy DE, Mayo-Smith WW, Ng T, DiPetrillo TA. Combined radiofrequency ablation and high-dose rate brachytherapy for early-stage non-small-cell lung cancer. *Brachytherapy* 2011;10(03):253-259
- Grieco CA, Simon CJ, Mayo-Smith WW, DiPetrillo TA, Ready NE, Dupuy DE. Percutaneous image-guided thermal ablation and radiation therapy: outcomes of combined treatment for 41 patients with inoperable stage I/II non-small-cell lung cancer. *J Vasc Interv Radiol* 2006;17(07):1117-1124
- Kim SR, Han HJ, Park SJ, et al. Comparison between surgery and radiofrequency ablation for stage I non-small cell lung cancer. *Eur J Radiol* 2012;81(02):395-399
- Kwan SW, Mortell KE, Hippe DS, Brunner MC. An economic analysis of sublobar resection versus thermal ablation for early-stage non-small-cell lung cancer. *J Vasc Interv Radiol* 2014;25(10):1558-1564, quiz 1565
- Zemlyak A, Moore WH, Bilfinger TV. Comparison of survival after sublobar resections and ablative therapies for stage I non-small cell lung cancer. *J Am Coll Surg* 2010;211(01):68-72
- Lee H, Jin GY, Han YM, et al. Comparison of survival rate in primary non-small-cell lung cancer among elderly patients treated with radiofrequency ablation, surgery, or chemotherapy. *Cardiovasc Intervent Radiol* 2012;35(02):343-350
- Crabtree T, Puri V, Timmerman R, et al. Treatment of stage I lung cancer in high-risk and inoperable patients: comparison of prospective clinical trials using stereotactic body radiotherapy (RTOG 0236), sublobar resection (ACOSOG Z4032), and radiofrequency ablation (ACOSOG Z4033). *J Thorac Cardiovasc Surg* 2013;145(03):692-699
- Alexander ES, Machan JT, Ng T, Breen LD, DiPetrillo TA, Dupuy DE. Cost and effectiveness of radiofrequency ablation versus limited surgical resection for stage I non-small-cell lung cancer in elderly patients: is less more? *J Vasc Interv Radiol* 2013;24(04):476-482
- Mouli SK, Kurilova I, Sofocleous CT, Lewandowski RJ. The role of percutaneous image-guided thermal ablation for the treatment of pulmonary malignancies. *AJR Am J Roentgenol* 2017;209(04):740-751
- Vogl TJ, Naguib NN, Gruber-Rouh T, Koitka K, Lehnert T, Nour-Eldin NE. Microwave ablation therapy: clinical utility in treatment of pulmonary metastases. *Radiology* 2011;261(02):643-651
- de Baère T, Aupérin A, Deschamps F, et al. Radiofrequency ablation is a valid treatment option for lung metastases: experience in 566 patients with 1037 metastases. *Ann Oncol* 2015;26(05):987-991
- Simon CJ, Dupuy DE, DiPetrillo TA, et al. Pulmonary radiofrequency ablation: long-term safety and efficacy in 153 patients. *Radiology* 2007;243(01):268-275
- Yamakado K, Inoue Y, Takao M, et al. Long-term results of radiofrequency ablation in colorectal lung metastases: single center experience. *Oncol Rep* 2009;22(04):885-891

- 38 Okuma T, Matsuoka T, Yamamoto A, et al. Determinants of local progression after computed tomography-guided percutaneous radiofrequency ablation for unresectable lung tumors: 9-year experience in a single institution. *Cardiovasc Intervent Radiol* 2010;33(04):787–793
- 39 Chua TC, Sarkar A, Saxena A, Glenn D, Zhao J, Morris DL. Long-term outcome of image-guided percutaneous radiofrequency ablation of lung metastases: an open-labeled prospective trial of 148 patients. *Ann Oncol* 2010;21(10):2017–2022
- 40 de Baere T, Tselikas L, Woodrum D, et al. Evaluating cryoablation of metastatic lung tumors in patients—safety and efficacy: the ECLIPSE trial—interim analysis at 1 year. *J Thorac Oncol* 2015;10(10):1468–1474
- 41 Aziz A, Ashizawa K, Nagaoki K, Hayashi K. High resolution CT anatomy of the pulmonary fissures. *J Thorac Imaging* 2004;19(03):186–191
- 42 Al-Hakim RA, Abtin FG, Genshaft SJ, Kutay E, Suh RD. Defining new metrics in microwave ablation of pulmonary tumors: ablation work and ablation resistance score. *J Vasc Interv Radiol* 2016;27(09):1380–1386
- 43 Nakatsuka S, Yashiro H, Inoue M, et al. On freeze-thaw sequence of vital organ of assuming the cryoablation for malignant lung tumors by using cryoprobe as heat source. *Cryobiology* 2010;61(03):317–326
- 44 Hinshaw JL, Littrup PJ, Durick N, et al. Optimizing the protocol for pulmonary cryoablation: a comparison of a dual- and triple-freeze protocol. *Cardiovasc Intervent Radiol* 2010;33(06):1180–1185
- 45 Pan PJ, Bansal AK, Genshaft SJ, Kim GH, Suh RD, Abtin F. Comparison of double-freeze versus modified triple-freeze pulmonary cryoablation and hemorrhage volume using different probe sizes in an in vivo porcine lung. *J Vasc Interv Radiol* 2018;29(05):722–728
- 46 Littrup PJ, Mody A, Sparschu R, et al. Prostatic cryotherapy: ultrasonographic and pathologic correlation in the canine model. *Urology* 1994;44(02):175–183, discussion 183–184
- 47 Abtin F, Quirk MT, Suh RD, et al. Percutaneous cryoablation for the treatment of recurrent malignant pleural mesothelioma: safety, early-term efficacy, and predictors of local recurrence. *J Vasc Interv Radiol* 2017;28(02):213–221
- 48 Abtin F, Suh RD, Nasehi L, et al. Percutaneous cryoablation for the treatment of recurrent thymoma: preliminary safety and efficacy. *J Vasc Interv Radiol* 2015;26(05):709–714
- 49 Sabel MS. Cryo-immunology: a review of the literature and proposed mechanisms for stimulatory versus suppressive immune responses. *Cryobiology* 2009;58(01):1–11
- 50 Wang H, Littrup PJ, Duan Y, Zhang Y, Feng H, Nie Z. Thoracic masses treated with percutaneous cryotherapy: initial experience with more than 200 procedures. *Radiology* 2005;235(01):289–298
- 51 Kawamura M, Izumi Y, Tsukada N, et al. Percutaneous cryoablation of small pulmonary malignant tumors under computed tomographic guidance with local anesthesia for nonsurgical candidates. *J Thorac Cardiovasc Surg* 2006;131(05):1007–1013
- 52 Shi F, Li G, Zhou Z, et al. Microwave ablation versus radiofrequency ablation for the treatment of pulmonary tumors. *Oncotarget* 2017;8(65):109791–109798
- 53 Vogl TJ, Eckert R, Naguib NN, Beeres M, Gruber-Rouh T, Nour-Eldin NA. Thermal ablation of colorectal lung metastases: retrospective comparison among laser-induced thermotherapy, radiofrequency ablation, and microwave ablation. *AJR Am J Roentgenol* 2016;207(06):1340–1349
- 54 Planché O, Teriitehau C, Boudabous S, et al. In vivo evaluation of lung microwave ablation in a porcine tumor mimic model. *Cardiovasc Intervent Radiol* 2013;36(01):221–228
- 55 Skonieczki BD, Wells C, Wasser EJ, Dupuy DE. Radiofrequency and microwave tumor ablation in patients with implanted cardiac devices: is it safe? *Eur J Radiol* 2011;79(03):343–346
- 56 Kashima M, Yamakado K, Takaki H, et al. Complications after 1000 lung radiofrequency ablation sessions in 420 patients: a single center's experiences. *AJR Am J Roentgenol* 2011;197(04):W576–580
- 57 Chan VO, McDermott S, Malone DE, Dodd JD. Percutaneous radiofrequency ablation of lung tumors: evaluation of the literature using evidence-based techniques. *J Thorac Imaging* 2011;26(01):18–26
- 58 Zheng A, Wang X, Yang X, et al. Major complications after lung microwave ablation: a single-center experience on 204 sessions. *Ann Thorac Surg* 2014;98(01):243–248
- 59 Zhu JC, Yan TD, Morris DL. A systematic review of radiofrequency ablation for lung tumors. *Ann Surg Oncol* 2008;15(06):1765–1774
- 60 Sakurai J, Hiraki T, Mukai T, et al. Intractable pneumothorax due to bronchopleural fistula after radiofrequency ablation of lung tumors. *J Vasc Interv Radiol* 2007;18(1, Pt 1):141–145
- 61 Kodama H, Yamakado K, Murashima S, et al. Intractable bronchopleural fistula caused by radiofrequency ablation: endoscopic bronchial occlusion with silicone embolic material. *Br J Radiol* 2009;82(983):e225–e227
- 62 Powell DK, Baum S. Bronchopleural fistula treated with N-butyl cyanoacrylate glue after ablation. *J Vasc Interv Radiol* 2018;29(12):1692–1693
- 63 Okuma T, Matsuoka T, Yamamoto A, et al. Frequency and risk factors of various complications after computed tomography-guided radiofrequency ablation of lung tumors. *Cardiovasc Intervent Radiol* 2008;31(01):122–130
- 64 Hiraki T, Tajiri N, Mimura H, et al. Pneumothorax, pleural effusion, and chest tube placement after radiofrequency ablation of lung tumors: incidence and risk factors. *Radiology* 2006;241(01):275–283
- 65 Abtin FG, Eradat J, Gutierrez AJ, Lee C, Fishbein MC, Suh RD. Radiofrequency ablation of lung tumors: imaging features of the postablation zone. *Radiographics* 2012;32(04):947–969