

The Application of Low-Valent Titanium Reagents in Organic Synthesis

Dieter Lenoir

Lehrstuhl für Ökologische Chemie und Geochemie der Universität Bayreuth, Postfach 101251, D-8580 Bayreuth, Federal Republic of Germany

The number and variety of applications of low-valent titanium reagents has expanded greatly since their initial use in 1973. This review examines the preparation of low-valent titanium reagents and their development as reagents for inter- and intramolecular coupling, reductive elimination and alkydenation, with reference to aspects of the mechanism and stereoselectivity.

- | | |
|--|--|
| <ol style="list-style-type: none"> 1. Introduction 2. Low-Valent Titanium Reagents 2.1. Preparation 2.2. Mechanism and Stereoselectivity 3. Intermolecular Coupling of Aldehydes and Ketones 3.1. Preparation of Alkenes 3.1.1. Preparation of Strained Ethylenes 3.1.2. Preparation of Aromatic Olefins 3.1.3. Mixed Coupling of Carbonyl Groups | <ol style="list-style-type: none"> 3.1.4. Scope and Limitation of the Coupling Reaction 3.1.5. Selective Coupling of Ketones and Aldehydes 3.1.5.1. Groups with Large Reduction Potentials 3.1.5.2. Groups with Low Reduction Potentials 3.2. Preparation of Glycols 3.2.1. Mixed Coupling of Carbonyl Compounds 4. Intramolecular Couplings of Carbonyl Groups 4.1. Preparation of Cycloalkenes and Cyclic Ketones 4.2. Preparation of Cyclic Diols 5. Reductive Eliminations 5.1. Deoxygenation of Glycols 5.2. Reductive Eliminations of Other Groups 6. Alkydenation of Carbonyl Groups 6.1. Methyleneations 6.2. Alkydenations 7. Conclusions and Summary |
|--|--|

1. Introduction

The reductive coupling of aldehydes and ketones to give alkenes by low-valent titanium species, generated *in situ*, was first reported independently between 1973 and 1974 by Tyrlik et al.,¹ Mukaiyama et al.,² and McMurry et al.³ The latter used titanium trichloride and lithium aluminum hydride to generate the low-valent titanium species; this has been further elaborated by McMurry and co-workers,^{4,5} and is now generally referred to as, "the McMurry reaction". The reaction conditions have also been modified, for instance titanium tetrachloride / zinc has been developed as a reagent and is now widely used.^{2,6} The reaction has also been reviewed, the applications of the reaction were covered some years ago.^{5,7,8,9} A detailed study of the mechanism of the reaction has also been published by Geise and co-workers.¹⁰

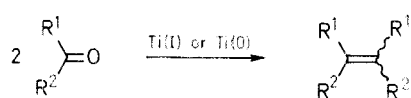

R¹ = alkyl, aryl
R² = H, alkyl, aryl

After a short introduction into the mechanistic aspects, the scope and applications of low-valent titanium species in synthetic organic chemistry will be covered in depth. Recent advances in the alkydenation of carbonyl compounds using titanium carbene complexes will also be discussed.

2. Low-Valent Titanium Reagents

2.1. Preparation

The yield and stereoselectivity of low-valent titanium coupling reactions are dependent upon; the choice of titanium reagent, its preparation, and the applied experimental conditions.¹⁰ The reagents and solvents must be pure and absolutely dry, since traces of oxidation and hydrolysis products can interfere with the reaction and reduce the yield. The reaction should therefore be performed under a dry argon atmosphere.

A Ti(0) or a Ti(I) species can be prepared depending on the reducing conditions applied.¹⁰ Titanium trichloride is reduced by lithium aluminum hydride^{4,5} according to the stoichiometric equation:

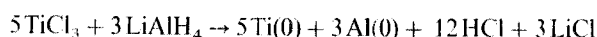

The following reducing agents have also been applied to titanium trichloride; lithium,^{10,11} sodium,¹⁰ potassium,^{4,10} potassium-graphite intercalate (C₈K),¹² magnesium,^{1,10} zinc-copper couple,¹³ and Rieke-titanium.¹⁴ It has been found that a slight excess of reducing agent is usually necessary to obtain an optimum yield of the desired product.¹⁰ Titanium trichloride and lithium aluminum hydride can produce a Ti(0) or a Ti(I) species depending on the mole ratio of TiCl₃/LiAlH₄, a ratio of 1:0.6 produces a Ti(0) species and 1:0.5 a Ti(I) species. Both of these reagents are commercially available.

Starting from titanium tetrachloride, the reduction to low-valent titanium can be performed by zinc,^{2,6} zinc-copper couple,¹⁵ magnesium/mercury,¹⁶ aluminum/aluminum trichloride,¹⁶ or

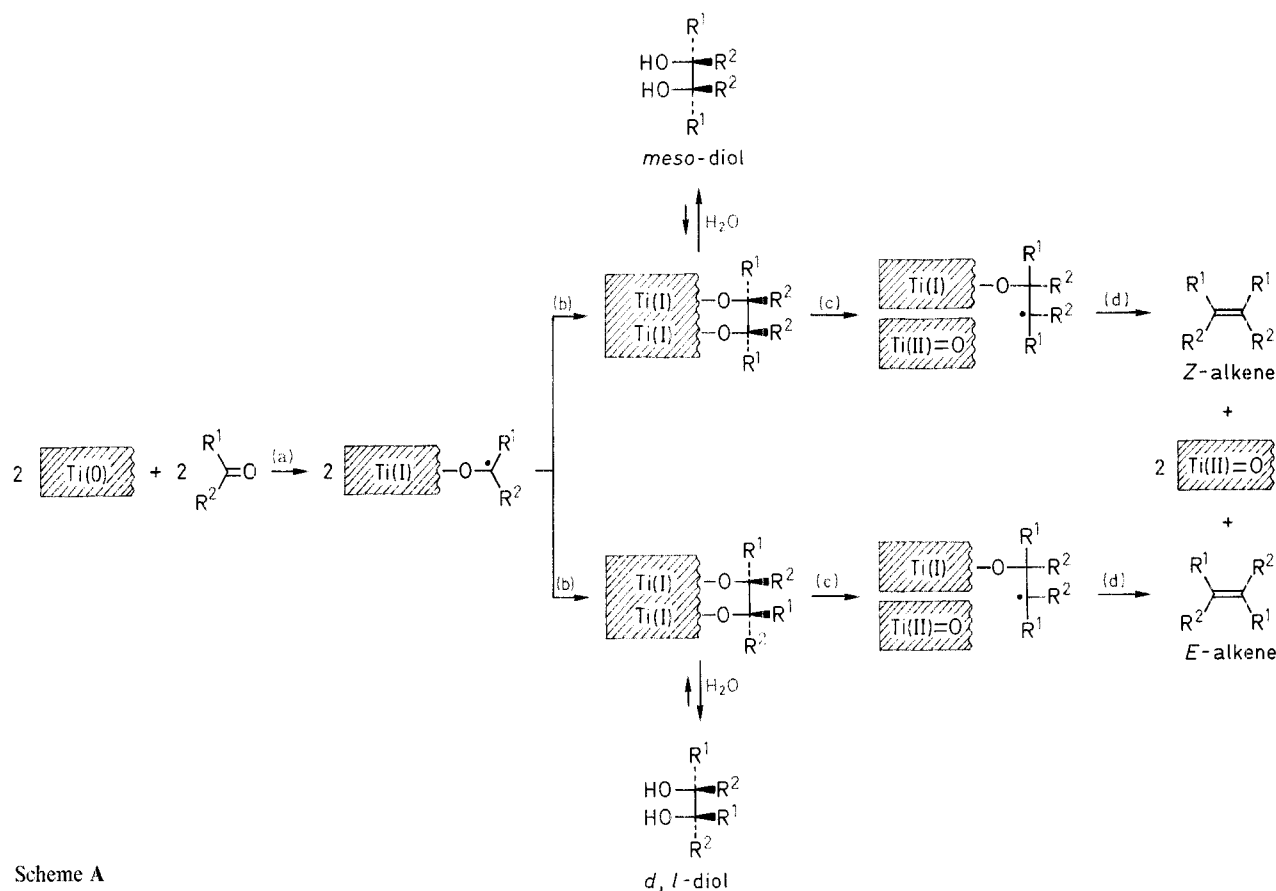

Scheme A

lithium aluminum hydride.¹⁷ Dicyclopentadienyltitanium dichloride and trimethylaluminum,^{16,18} or with Grignard reagents,¹⁹ has also been used.

Tetrahydrofuran is usually the solvent of choice for the reaction but dioxane and dimethoxyethane are also applied. The reaction conditions have also been carefully elaborated to obtain optimum yields by the preparation of a crystalline titanium trichloride dimethoxyethane complex which is reduced by zinc-copper couple.²⁰

2.2. Mechanism and Stereoselectivity

A black slurry of low-valent titanium species is freshly prepared, the carbonyl compound is added and the reaction is allowed to proceed for a fixed time. The sequence of events is depicted mechanistically, both in solution and on the surface of the titanium, in Scheme A.

In the initial step (a), an electron is transferred from titanium to the carbonyl group generating a radical anion, which has been detected by ESR-spectroscopy.¹⁰ The ketyl radical then dimerizes to the corresponding pinacol (b), which can be isolated as the primary reaction product when low temperatures are used. Deoxygenation by a *cis*-type concerted mechanism of the pinacol occurs readily (c and d) leading to alkenes, due to the large affinity of titanium for oxygen. These reactions all occur on the surface of the titanium.^{5,10}

Stereoselectivity is observed in diol formation (ratio of *meso* to *d,l*-isomers) as well as in olefin formation (ratio of *E/Z*-isomers); these effects will be described below. The stereoselectivity of the olefin formation depends on the choice of the titanium reagent.⁶ The *E/Z*-ratio in coupling of aliphatic methyl alkyl ketones depends strongly on the steric bulk of the alkyl groups.⁶

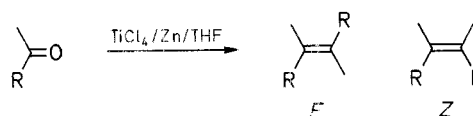

| R | Ratio <i>E/Z</i> |
|--|------------------|
| CH ₂ CH ₂ CH ₃ | 3:1 |
| CH ₂ C(CH ₃) ₃ | 4:1 |
| CH(CH ₃) ₂ | 6:1 |
| C(CH ₃) ₃ | > 200:1 |

The observed *E/Z* ratios are different when the low-valent titanium species is generated from TiCl₃/LiAlH₄; for example the ratio of *E/Z* is close to unity in alkene formation from pinalone. The stereoselectivity of stilbene formation from benzaldehyde is also dependent on the reagents used to generate the titanium species.^{1,2,3}

A complete rationale for these results has still to be found. The deoxygenation step also shows stereoselective behavior; *meso*- and *d,l*-isomers of the same glycols give different mixtures of *E/Z* isomeric alkenes.⁴ More examples of this behavior will be given later.

3. Intermolecular Coupling Aldehydes and Ketones

3.1. Preparation of Alkenes

Low-valent titanium reagents have been widely used for the preparation of symmetrical alkenes, starting from the corresponding aldehyde or ketone. There are many examples, for a selection refer to previous reviews.^{5,7,8,9}

Some synthetically useful examples will be discussed in this section. β -Carotene (**2**), a food coloring compound and precursor of vitamin A, can be prepared in high yield from retinal (**1**). The titanium reagent for the coupling can either be $\text{TiCl}_3/\text{LiAlH}_4$,³ or $\text{TiCl}_4/\text{LiAlH}_4$ in the presence of a proton sponge.¹⁷ Dimestrole (**4**), precursor of diethylstilbestrol, can be prepared from the ketone **3**.⁴

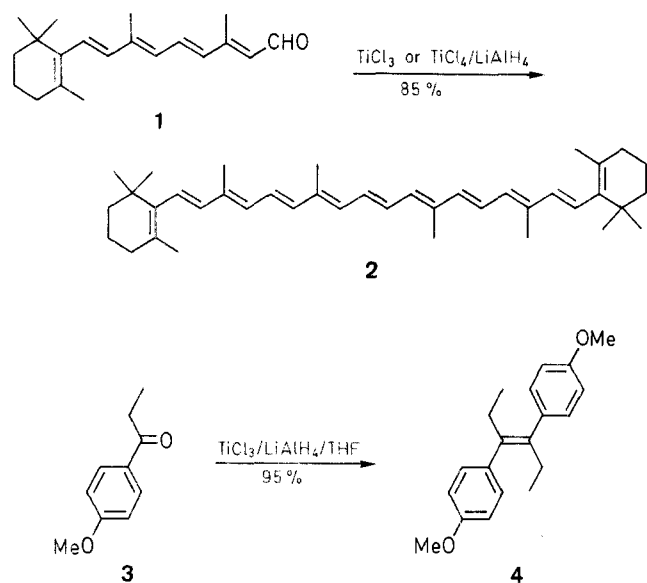

4,4'-homoadamantylidenehomoadamantane (**8**),²⁵ tetracyclopropylethylene (**9**)⁶ and its derivatives,²⁶ and finally the highly nucleophilic olefin 10,10'-bi(trispiro)[2.0.2.0.2.1]decylidene (**10**).²⁷

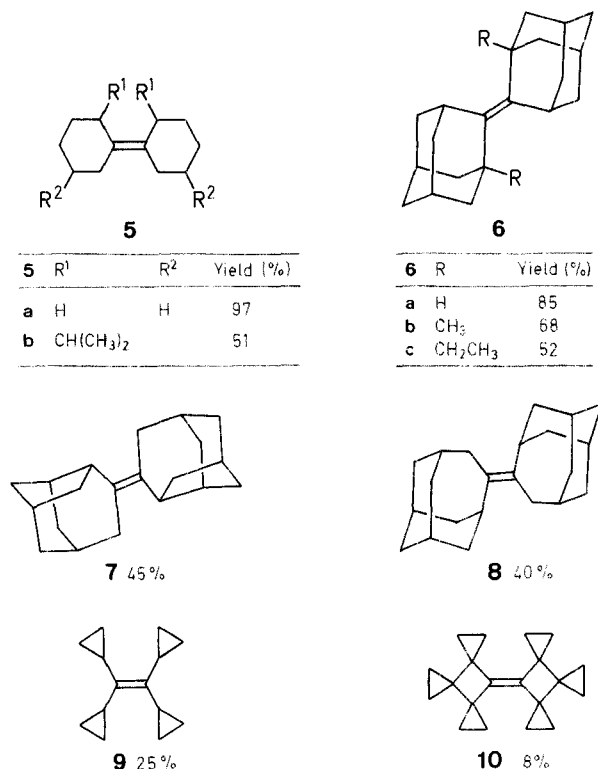

Worthy of note are the synthesis of mini-carotene, a lower homologue of β -carotene (**2**),²¹ and the C₄₀-saturated terpenoid used as a crude oil marker.²²

Reductive Coupling of Aldehyde and Ketones; General Procedure

Method A:⁴ K metal (1.92 g, 49 mmol) is washed with hexane to remove oil and is added to a stirred slurry of TiCl_3 (2.15 g, 14 mmol) in dry THF (75 mL) at r.t. under an inert atmosphere. After refluxing for 40 min, the black mixture is cooled and a solution of ketone or aldehyde (3.5 mmol) in THF (5 mL) is added. After a further 16 h at reflux, the reaction mixture is cooled to r.t. and transferred by syringe to a glass filtration tube (medium frit) under an inert atmosphere. The mixture is vacuum filtered, and the filtrate is then concentrated by solvent removal on a rotary evaporator to yield the crude product. In this manner tetraisopropylethylene and 10-icosene are isolated by chromatography, in 37% and 60% yield, respectively.

Method B:⁶ Zn dust (10 g, 150 mg-atom) is added in small portions to TiCl_4 (14.2 g, 8.2 mL, 75 mmol) in THF (200 mL) with ice cooling under an N₂ atmosphere. Pyridine (5 mL) and ketone (70 mmol) in THF (200 mL) are added. The mixture is heated at reflux for 20 h. After being cooled to r.t., the reaction is quenched with 10% aq. K₂CO₃ (150 mL). The mixture is extracted with Et₂O or pentane (5 × 50 mL). The extract is washed with water twice, dried (MgSO₄), filtered, and concentrated under vacuum. The residue is isolated by chromatography on silica (Merck 60, 0.2–0.6 mm, 60 g) using pentane or hexane as an eluent. The alkene is obtained after evaporation of the solvent and further purified by standard procedures.

We have developed the latter procedure (Method B) and used it for the coupling of a wide variety of ketones. Although yields are sometimes a little lower compared to other procedures, the method is easy to perform and the reagents are less expensive. The addition of pyridine is not essential in most cases.

In general most monocyclic ketones of varying ring size, as well as polycyclic ketones, can be coupled to give the corresponding alkenes. The following alkenes have thus been obtained: cyclohexylidene-cyclohexane (**5a**)^{4,20} and the alkyl derivative **5b**,⁶ adamantylideneadamantane (**6**)⁴ and the alkyl derivatives **6b**, **6c**²³ (4-protoadamantylidene)4-protoadamantane **7**,^{6,24}

3.1.1. Preparation of Strained Ethylenes

The coupling of ketones with low-valent titanium reagent is an effective method for the synthesis of highly strained ethylenes. Several strained ethylenes have been produced by this method (Table 1, 2). The yields are generally low, however, alternative synthetic routes have been unsuccessful for some of these compounds.

Table 1. Preparation of Strained Ethylenes

| Starting Material | Product | Reagent | Yield (%) | Ref. |
|-------------------|---------|--|-----------------|------|
| | | $\text{TiCl}_3/\text{K}/\text{THF}$ | 37 | 28 |
| | | $\text{TiCl}_3/\text{LiAlH}_4/\text{THF}$ | 12 | 29 |
| | | $\text{TiCl}_3/\text{Zn}-\text{Cu}/\text{DME}$ | 94 | 20 |
| | | $\text{TiCl}_3/\text{LiAlH}_4/\text{THF}$ | 40 | 30 |
| | | $\text{TiCl}_4/\text{Zn}/\text{THF}$ | 68 ^a | 31 |
| | | $\text{TiCl}_4/\text{LiAlH}_4/\text{THF}$ | 70 ^b | 32 |
| | | $\text{TiCl}_3/\text{LiAlH}_4/\text{THF}$ | 8 ^c | 33 |
| | | $\text{TiCl}_3/\text{LiAlH}_4/\text{THF}$ | 13 | 34 |

^a *E*-isomer only.

^b *E/Z* ratio = 1 : 1.

^c *E/Z* ratio = 12 : 1.

1-Ethyladamantanone couples to give the strained ethylene **6c**,²³ but neither *tert*-butyl isopropyl ketone,³⁵ nor di-*tert*-butyl ketone^{36,37} could be coupled to give the corresponding alkene by any of the low-valent titanium species. The reaction of di-*tert*-butyl ketone with $\text{TiCl}_3/\text{LiAlH}_4$ in refluxing dioxane yields exclusively di-*tert*-butyl carbinol,³⁶ no C,C-coupling is observed. *tert*-Butyl cyclopropyl ketone reacts with low-valent titanium to give a complex mixture of products.³⁵ A small amount of C,C-coupled saturated material can be isolated, demonstrating the limitations of the reaction due to severe steric hindrance. For comparison with alternative alkene syntheses see Section 3.1.4.

3.1.2. Preparation of Aromatic Olefins

Sterically uncrowded and crowded stilbene derivatives **12** have been prepared from ketones **11** by a low-valent titanium coupling reaction (Table 2).

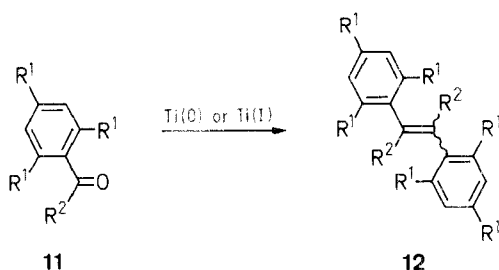

Table 2. Coupling of Aryl Ketones **11** to give Stilbenes **12**

| 11 | R ¹ | R ² | Reagent | Yield (%) | <i>E</i> / <i>Z</i> ratio | Ref. |
|-----------|----------------|----------------------------|---|-----------|---------------------------|--------|
| a | H | H | $\text{TiCl}_4/\text{Zn}/\text{THF}$ | 88 | 1 : 4 | 1 |
| | | | $\text{TiCl}_3/\text{Zn}/\text{dioxane}$ | 98 | 99 : 1 | 2 |
| | | | $\text{TiCl}_3/\text{LiAlH}_4/\text{THF}$ | 97 | ~85 : 15 | 3 |
| b | H | CH_3 | $\text{TiCl}_4/\text{Zn}/\text{THF}$ | 81 | 26 : 74 | 38 |
| c | H | CH_2CH_3 | $\text{TiCl}_4/\text{Zn}/\text{THF}$ | 59 | 27 : 73 | 38 |
| d | H | $\text{CH}(\text{CH}_3)_2$ | $\text{TiCl}_4/\text{Zn}/\text{THF}$ | 25 | 88 : 12 | 38, 41 |
| | | | $\text{TiCl}_3/\text{Li}/\text{THF}$ | 45 | ~100 : 1 | 36 |
| e | H | $\text{C}(\text{CH}_3)_3$ | $\text{TiCl}_4/\text{Zn}/\text{THF}$ | 82 | ~100 : 1 | 39 |
| f | CH_3 | H | $\text{TiCl}_4/\text{Zn}/\text{THF}$ | 22 | 1 : 1.2 | 40 |
| g | CH_3 | CH_3 | $\text{TiCl}_3/\text{Li}/\text{THF}$ | 42 | 1 : 1.8 | 40 |
| h | OMe | CH_3 | $\text{TiCl}_3/\text{Li}/\text{THF}$ | | | |

The preference for formation of *Z*-products of uncrowded stilbenes **12a**, **12f**, has been attributed to complexation and stabilization of the two aromatic moieties by titanium possible only in the *meso*-diol form, which further yields the *Z*-stilbene on deoxygenation.³⁸ Whilst TiCl_4/Zn yields *Z*-products preferentially (**12a–e**), *E*-stilbene **12a** is formed in the coupling reaction when $\text{TiCl}_3/\text{LiAlH}_4$ is the reagent.³

tert-Butyl phenyl ketone (**11e**) yields exclusively the crowded *E*-stilbene **12e**, regardless of the reagent used to generate low-valent titanium; a detailed study of this chemistry has recently been published.⁴¹ In the coupling of the highly crowded ketones **11g**, **h**, formation of ethane derivatives is observed and reduced methylene compounds are isolated as side-products.⁴⁰ Supermesityl aldehyde (**11**: R¹ = $\text{C}(\text{CH}_3)_3$, R² = H) when reacted with $\text{TiCl}_3/\text{LiAlH}_4$ couples to give exclusively the ethane derivative 1,2-disupermesitylethane in 52% yield.⁴² Mesityl *tert*-butyl ketone and dimesityl ketone³⁵ do not give

C,C-coupling products when reacted with low-valent titanium reagents.^{40,41} This shows the limitation of the reaction, as severe steric crowding would be present in the hypothetical coupled products.

Diaromatic ketones, for example, benzophenone,⁴ 9-fluorenone,³ and 1,1'-dinaphthyl ketone,⁴² on treatment with low-valent titanium give the corresponding aryl ethylenes in excellent yields. Phenyl 3-pyridyl ketone gives the corresponding ethylene in 31% yield.⁴³ Di-*o*-tolyl ketone yields the tetra-*o*-tolyl ethylene along with small amounts of the ethane derivative.⁴⁴ Surprisingly, coupling of the dibenzocycloheptanone **13** using TiCl_4/Zn does not yield the expected product **14**, but results in the formation of the chiral bridged diphenylanthracene **15** and the ethane derivative **16**.⁴⁵

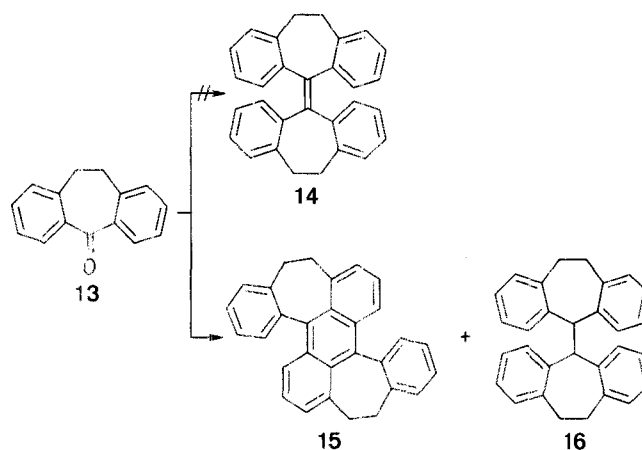

Benzylated cyclic ketones **17** can be coupled to give cyclic stilbene derivatives **18** (Table 3).

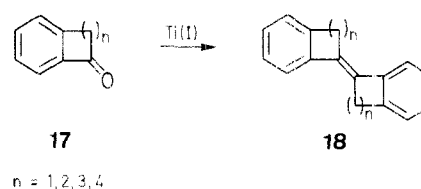
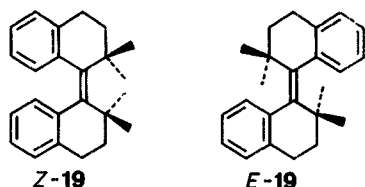

Table 3. Coupling of Ketones **17** to give Cyclic Stilbenes **18**

| n | Reagent | Yield (%) | <i>E</i> / <i>Z</i> ratio | Ref. |
|---|---|-----------|---------------------------|------|
| 1 | $\text{TiCl}_3/\text{LiAlH}_4/\text{THF}$ | 62 | 9 : 1 | 46 |
| 2 | $\text{TiCl}_4/\text{Zn}/\text{THF}$ | 76 | 9 : 1 | 46 |
| 3 | $\text{TiCl}_4/\text{Zn}/\text{THF}$ | 78 | 7 : 3 | 46 |
| 4 | $\text{TiCl}_4/\text{Zn}/\text{THF}$ | 38 | 8 : 2 | 39 |

Several alkyl and methoxy derivatives of ketones **17** have been coupled successfully using low-valent titanium reagents.⁴⁶ Derivatives of **18** (n = 3) are useful starting materials in the preparation of perylene compounds.⁴² (*E*)-1-(3,4-Dihydro-2,2-dimethyl-1(2*H*)-naphthalenylidene)-1,2,3,4-tetrahydro-2,2-dimethylnaphthalene (**19**) and its *Z*-isomer have also been prepared and studied; due to severe crowding of the stilbene system only the *E*-isomer can be isolated in crystalline form because of the very low *Z*/*E* barrier of 21 kcal/mol observed in solution since *Z*-**19** rearranges instantaneously to *E*-**19**.⁴⁷



3.1.3. Mixed Coupling of Carbonyl Groups

The intermolecular coupling of identical aldehydes and ketones yields symmetrical olefins. A mixture of two different carbonyl compounds will react generally to a nearly statistical mixture of olefins when subjected to low-valent titanium.⁴⁸ Some new olefins have been prepared by this method, e.g. crowded ethylenes **20** from the reaction of pivalaldehyde/corresponding ketone in a 4:1 mole ratio.⁴⁹ The crowded ethylenes **20a,b** have been used for the determination of thermal barriers to *Z/E* isomerization; 1,2-dimethyl- and 1,2-diethyl-di-*tert*-butylethylenes (Table 1) have also been used for this purpose.⁴⁹

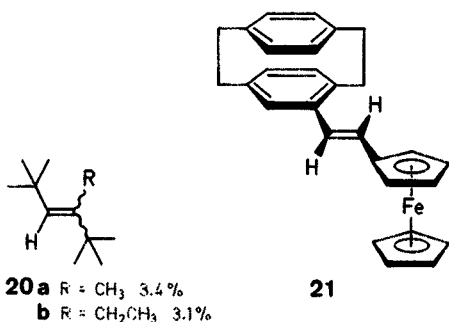

1-(2-[2.2]-Paracyclophano)-2-ferrocenylethylene (**21**) can be prepared by mixed coupling of either aldehyde in 33% yield.⁵⁰

By applying an excess of one carbonyl compound mixed coupling can be synthetically useful, for example, in the isopropylideneation of carbonyl groups using an excess of acetone. Cholestanone (**22**) gives the mixed coupled product **23** in 54% yield; cholestanylidenecholestane is only formed in 29% yield.⁴⁸ Adamantanone gives the isopropylidene derivative with a yield of 63% under the same conditions.⁴⁸

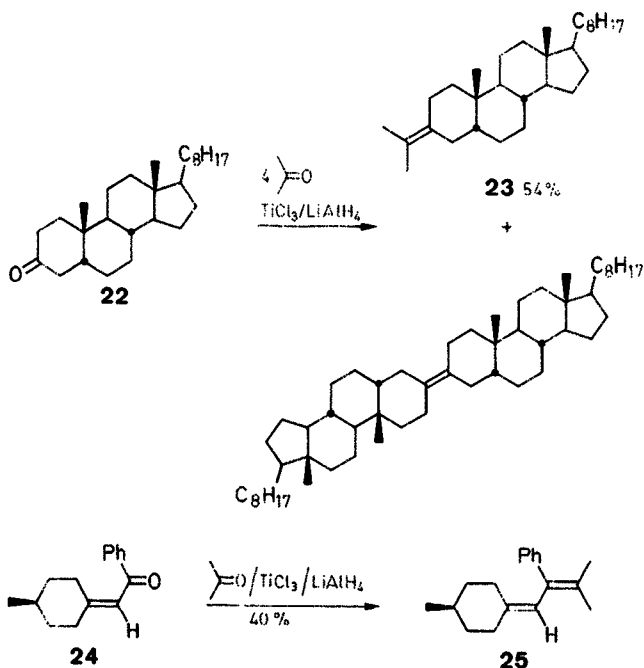

The chiral diene **25** has been prepared by the same methodology from *R*-(-)-(4-methylcyclohexylidene)acetophenone (**24**).⁵¹ Mixed coupling can sometimes be faster than self-condensation of either carbonyl compound; for example, the vetispiene derivative **28** can be prepared from ketone **26** and the cyclic aldehyde **27**.⁵²

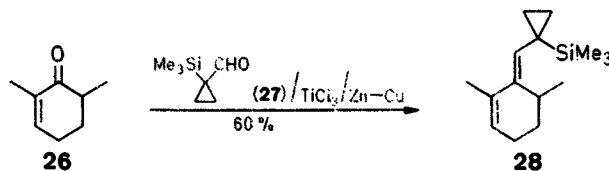

It is also possible to couple mixtures of dialkyl- and diaryl ketones (Scheme B). The mixed coupling of equimolar amounts of benzophenone and cyclohexanone gives 1,1-dihexyl-2,2-diphenylethylene in 78% yield, with the self-condensation products tetraphenylethylene and cyclohexyldienecyclohexane in 19% and 6% yield, respectively.⁴⁸

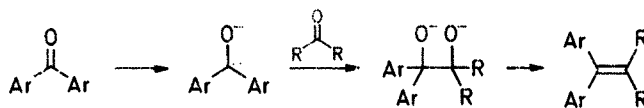

Scheme B

Mechanistically this can be explained in terms of the different reduction potentials of the ketones. As the second reduction potential of diaryl ketones is less negative than the first reduction potential of dialkyl ketones, the initial step is two-electron transfer from low-valent titanium to the diaryl ketone. The dianion thus formed then adds to the dialkyl ketone to give a mixed pinacol product, which is further deoxygenated to yield the alkene.⁴⁸

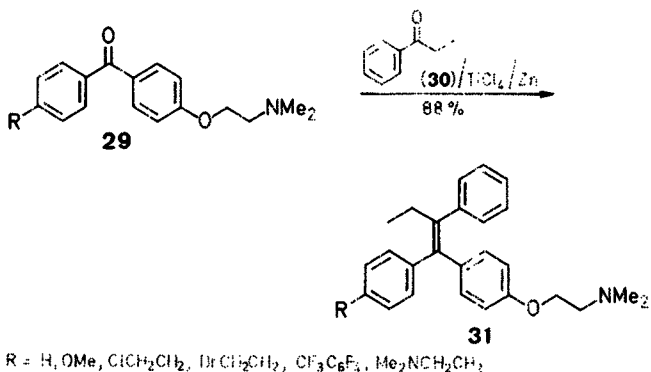

Mixed coupling has also been applied in synthesis of the antitumor agent tamoxifen (**31**, R = H) by the coupling of ketones **29** and **30**. Several derivatives of tamoxifen (**31**) have also been prepared starting from the substituted benzophenone **30**.⁵³

3.1.4. Scope and Limitation of the Coupling Reaction

The coupling reaction can be compared with two more recent alkene preparations. The Barton-Kellogg method (thiadiazoline method),⁵⁴ makes use of the cycloaddition of thio- or selenoketones **32** to diazoalkanes **33** yielding the five-membered heterocycles **34**, which are subjected to a double extrusion process to give alkenes **35**.

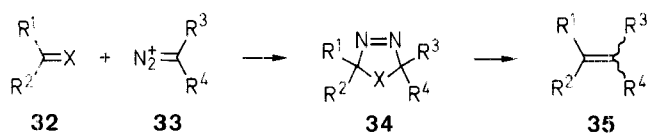

X = S, Se
R¹ = R² = R³ = R⁴ = alkyl, aryl

The disadvantages of the Barton–Kellogg method are that; the preparation of the alkenes **35** involves three complicated steps starting from the parent ketone; highly crowded unsymmetrical thiadiazolines can show retro-cycloreversion reactions to yield complex alkene mixtures,⁵⁶ it is not possible to synthesize some of the alkenes cited in Table 1 as again complex product mixtures result.⁴⁷ However, the Barton–Kellogg method allows the synthesis of many unsymmetrical alkenes.^{54,59}

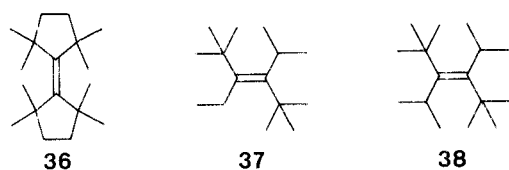

It is not possible to prepare tetra-*tert*-butylethylene by any known method; however, cyclic tied-back derivatives of this alkene, such as (2',2',5',5'-tetramethylcyclopentylidene)-2,2,5,5-tetramethylcyclopentane (**36**), have been prepared. Compound **36** can be prepared by the Barton–Kellogg method;^{55,57} it is not possible to prepare **36** by reductive coupling from the ketone by low-valent titanium.⁴² The Barton–Kellogg method has also been applied in the successful synthesis of the extremely crowded alkenes **37** and **38**.⁵⁸ 3,4-Di-*tert*-butyl-2,5-dimethyl-3-hexene (**38**) is the most hindered alkene prepared to date. It has a calculated strain energy of 61.4 kcal/mol, the thermal *Z/E* barrier is expected to be extremely low. Preparation of **37** and **38** using low-valent titanium coupling were unsuccessful.³⁵

In general, alkene synthesis by carbene dimerization are hampered by numerous side-reactions.⁵⁹ But synthesis of tetramesitylethylene was only accomplished by carbene dimerization.⁶⁰ A newly developed reaction, reductive coupling of thioacetals with molybdenum hexacarbonyl, has not been applied to highly crowded alkenes.⁶²

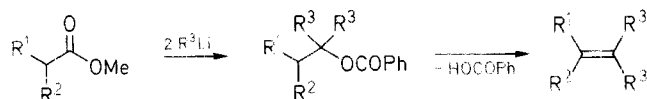

Scheme C

An alternative method (Scheme C) allows the preparation of a variety of symmetrical and unsymmetrical alkenes from carboxylic acid derivatives. Tri-*tert*-butylethylene and tetracyclopropylethylene have been prepared by this route.⁶² However, the reaction is limited in its initial step by the steric crowding of the starting carboxylic acid, for example, 1,2,2-trimethylbutyric acid and its methyl ester do not react with *tert*-butyllithium.⁶³ Thus attempted synthesis of tri-*tert*-butylmethylthylene failed as the initial step was unsuccessful. However, this alkene has been successfully prepared by another strategy by Krebs et al.⁵⁷ A modified version of this method has recently been

developed by Olah.⁶⁴ Ketone **39** react with isopropyllithium to give the carbinol **40**, which is dehydrated to the alkene **41** without isolation.

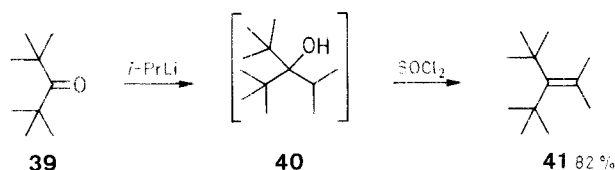

3.1.5. Selective Coupling of Ketones and Aldehydes

3.1.5.1. Groups with Large Reduction Potentials

Low-valent titanium coupling methods can tolerate the presence of various functional groups in the molecules to be coupled. Carbon–carbon double bonds are generally inert to all low-valent titanium species, and no isomerization is observed. Reports of coupling in the presence of carbon–carbon triple bonds are rare, and a partial hydrogenation seems to occur. Ethers and alcohols are generally stable under coupling conditions; however, 2-alkyl-3-ethoxyacroleins **42** react to give 2,5-dialkyl-2,4-hexadieneals **43** in moderate yields.⁶⁵ Benzyl,⁶⁶ and silyl ethers⁶⁷ generally pose no problems under these reaction conditions. Acetals have also been shown to be stable (see examples given below), as well as alkylvinylsilanes.⁴⁸ Special care must be taken in the workup conditions for acetals.

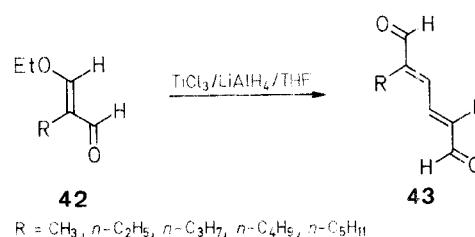

These are also several examples of the stability of secondary and tertiary amines under low-valent titanium coupling conditions. Aromatic halides do not interfere with the coupling reaction if the correct conditions are used, for example; the coupling of **44** to give **45**,⁶⁸ and **46** to give **47**.⁶⁹

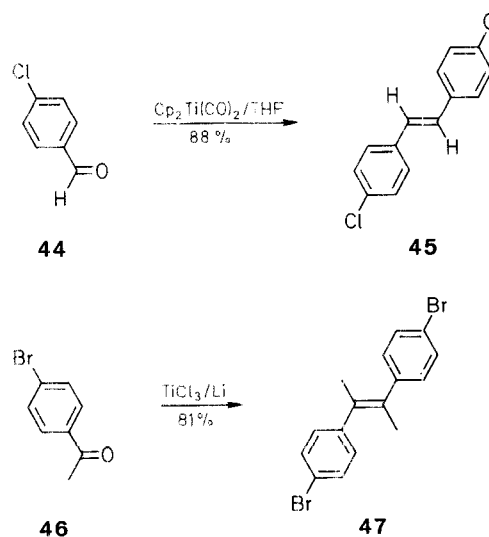

Cp = cyclopentadienyl

Under normal conditions ($\text{TiCl}_3/\text{LiAlH}_4$) aromatic iodides, bromides and chlorides can also be reduced to arenes.⁷⁰ A trifluoromethyl group present in the aryl system does not interfere with the coupling reaction.⁷⁰ Sulfides⁷¹ and selenides⁷² are also stable towards the reductive power of low-valent titanium. Amides are only stable under special conditions.⁷³ Ferrocene units are stable towards titanium tetrachloride and zinc,⁵⁰ for example, acetyl ferrocene can be coupled to the isomeric 2-butene derivatives.³⁶

3.1.5.2. Groups with Low Reduction Potentials

Aromatic aldehydes and ketones have been coupled in the presence of adjacent acyloxy, methoxy, methoxycarbonyl and tosyloxy groups using titanium trichloride/zinc-copper in dimethoxyethane.⁷⁴ Selected examples for the coupling of aromatic carbonyl compounds **48** to give stilbenes **49** are shown in Table 4.

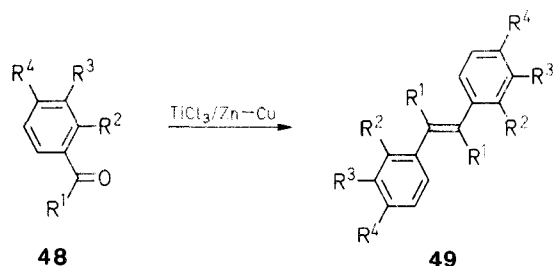

Table 4. Reductive Coupling of Aromatic Carbonyl Compound **48**

| 48 | R ¹ | R ² | R ³ | R ⁴ | Solvent | Yield (%) |
|-----------|-----------------|------------------|------------------|----------------|------------------|-----------|
| a | H | H | OAc | OMe | DME ^a | 87 |
| b | H | H | OMe | OAc | THF | 87 |
| c | CH ₃ | H | H | OAc | DME ^a | 64 |
| d | H | H | OTs ^b | H | THF | 80 |
| e | H | OTs ^b | H | H | THF | 92 |
| f | CH ₃ | OTs ^b | H | H | THF | 64 |

^a DME = dimethoxyethane.

^b OTs = 4-CH₃C₆H₄SO₃.

Noteworthy is the coupling of methyl benzoate using titanium trichloride/magnesium to give benzil (46%) and 1,2-dibenzoyl-1,2-diphenylethylene (20%).¹ Further examples of intramolecular coupling in the presence of ester groups are given later in this review.

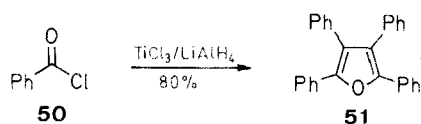

It is also possible to perform a selective coupling reaction in the presence of two different keto groups, if one group can cyclize intramolecularly; this interesting selectivity will be further discussed. Carboxylic acids do react with low-valent titanium. Benzoyl chloride (**50**) reacted in a one-pot reaction with titanium trichloride/lithium aluminum hydride to give tetraphenylfuran (**51**) in 80% yield.⁷⁰ The intermediates in this reaction have been shown to be benzil and 1,2-dibenzylstilbene.

Aromatic nitro compounds yield mixtures of azoarenes and amines, whilst a modification of the reaction conditions gives mixtures of substituted stilbenes and tolanes.⁷⁰

3.2. Preparation of Glycols

Aldehydes and ketones can be coupled to give pinacols with low-valent titanium (see Scheme D) using mild and special reaction conditions;² in general, the reaction is performed at 0 °C.

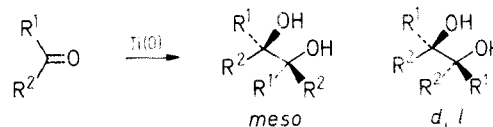

Scheme D

Diols cannot always be isolated, since deoxygenation can occur very quickly to give the alkene. In general mixtures of *meso*- and *d,l*-isomers are formed by coupling of unsymmetrical carbonyl compounds. *threo*-Selectivity has been obtained in the formation of symmetrical glycols using a cyclopentadienyl-bound titanium(III)-reagent, which is prepared from reaction of cyclopentadienyltitanium(IV) with Grignard reagents.⁷⁵ Some examples of glycol formation using low-valent titanium are shown in Table 5. In all cases tetrahydrofuran was used as the solvent.

Table 5. Intermolecular Coupling of Ketones and Aldehydes.

| Starting Material | Product | Reagent | Yield (%) | Ref. |
|-------------------|---------|---|---------------------|------|
| | | TiCl ₄ /Mg-Hg | 93 | 16 |
| | | TiCl ₃ /Mg | 45 | 1 |
| | | TiCl ₃ /C ₈ K (1:2) | 64 | 12 |
| | | TiCl ₄ /Mg-Hg | 95 | 16 |
| | | TiCl ₃ /C ₈ K (1:1) | 65 | 42 |
| | | TiCl ₄ /Zn | 98 | 2 |
| | | TiCl ₄ /Mg-Hg | 84 | 16 |
| | | Cp ₂ TiCl ₂ / <i>i</i> -PrMgI | (80:1) ^a | 75 |
| | | Cp ₂ Ti(CO) ₂ | 50 | 68 |
| | | TiCl ₄ /Zn | 91 | 2 |
| | | Cp ₂ Ti(CO) ₂ | 57 | 68 |

^a *Threo/erythro*.

1,2-Diphenylethane-1,2-diol; Typical Procedure:²

A suspension of zinc powder (0.59 g, 9 mmol) in THF (10 mL) is added slowly to a mixture of benzaldehyde (0.318 g, 3 mmol) and titanium tetrachloride (0.86 g, 4.5 mmol) in THF (20 mL) at -10° under Ar. The yellow solution immediately changes to purple and then turns dark brown. The mixture is stirred for 2 h at 0°, then 10% aq. K₂CO₃ solution (10 mL) is added and the solution extracted with Et₂O (50 mL). The solvent is evaporated *in vacuo* to give the diol; yield: 0.310 g (98%).

3.2.2. Mixed Coupling of Carbonyl Compounds

Corey et al.¹⁶ have successfully coupled carbonyl compounds to give unsymmetrical or mixed diols. Mixed coupling takes place when a cyclic ketone and a 3 mole excess of a carbonyl compound, such as acetone or acetaldehyde, are reacted with TiCl₃/Mg-Hg. The unsymmetrical diol can easily be separated from the product mixture by chromatography. For example, an equimolar mixture of cyclohexanone and acetone gives the mixed diol in 76% yield.¹⁶

A variation of the pinacol coupling, the reaction of aromatic aldehydes **52** with secondary amines and with titanium tetrachloride/magnesium gives *N,N,N',N'*-tetraalkyl-1,2-diaryl-1,2-ethanediamines **53** in good yield. The 1:1 mixture of *meso*- and *d,l*-isomers can be separated by crystallization or chromatography.⁷⁶ Various substituted aromatic aldehydes have been coupled in this way.

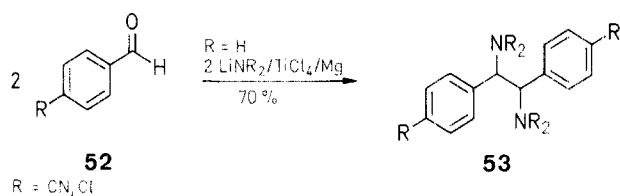

4. Intramolecular Coupling of Carbonyl Groups

4.1. Preparation of Cycloalkenes and Cyclic Ketones

Intramolecular coupling of α,ω -dicarbonyl compounds has been applied to the synthesis of cycloalkenes,⁵ intramolecular coupling of keto esters gives cyclic ketones.⁷⁷

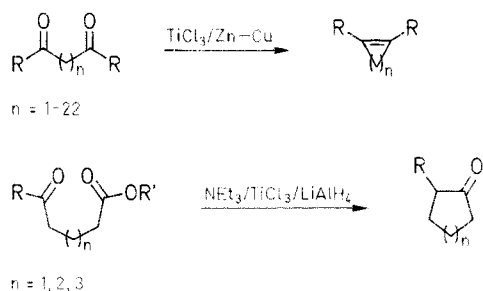

Cycloalkenes can be prepared in all ring sizes up to 22 carbon atoms, the low-valent titanium reagent is usually titanium trichloride/zinc-copper.⁵ Intramolecular keto ester coupling works only well with five-, six- and seven-membered rings.⁷⁷

Some typical examples of intramolecular coupling of α,ω -diketones are shown in Table 6. In general, tetrahydrofuran is the solvent, and high dilution conditions are used to avoid intermolecular reactions.⁵

Intramolecular coupling of dicarbonyl compounds has recently been optimized using titanium trichloride/dimethoxyethane solvate as the titanium source and zinc-copper as the reducing agent.²⁰ Yields for cyclic alkenes for medium-sized rings are much higher compared to those from the corresponding acyloin, Thorpe, and Dieckmann condensations.²⁰

Macrocyclic Dialdehyde Coupling:

Dimethoxyethane (DME) was distilled twice from K metal under an Ar atmosphere; pentane was distilled from CaH₂ and deoxygenated prior to use by purging with Ar for 10 min. All manipulations were carried out under an atmosphere of Ar and all transfers were done using Schlenk apparatus.

Preparation of TiCl₃ (DME)₂:

TiCl₃ (25.0 g, 0.162 mol) is suspended in dry DME (350 mL), and the mixture refluxed for 2 d under Ar. After cooling to r.t., the solid is filtered under Ar, washed with pentane (50 mL), dried under vacuum to give fluffy, blue crystalline TiCl₃ (DME)₂, yield: 32.0 g (80%) that is used in the coupling reaction. The solvate is air sensitive but can be stored indefinitely under Ar at r.t.

Preparation of Zinc-Copper Couple:

Zn-Cu couple is prepared by addition of Zn dust (9.8 g, 150 mmol) to N₂-purged water (40 mL), the slurry is purged with N₂ for 15 minutes,

Table 6. Intramolecular Dicarbonyl Coupling

| Starting Material | Product | Reagent | Yield (%) | Ref. |
|-------------------|---------|---|-----------|------|
| | | TiCl ₃ / LiAlH ₄ | 46 | 78 |
| | | TiCl ₃ / Zn-Cu | 87 | 79 |
| | | TiCl ₃ / LiAlH ₄ | 40-61 | 78 |
| | | TiCl ₃ / LiAlH ₄ | 78 | |
| | | TiCl ₃ / Zn-Cu | 50 | 79 |
| | | TiCl ₃ / LiAlH ₄ | 61 | 78 |
| | | TiCl ₃ / Zn-Cu | 76 | 79 |
| | | TiCl ₃ /Li | 61 | 77 |
| | | TiCl ₃ / Zn-Cu | 85 | 79 |
| | | TiCl ₄ / Zn | 30 | 72 |
| | | TiCl ₄ / Zn | 73 | 71 |

and addition of CuSO₄ (0.75 g, 4.7 mmol). The black slurry is filtered under N₂, washed with deoxygenated (nitrogen-purged) water (10 mL), acetone (10 mL), and Et₂O (10 mL), and dried under vacuum. The couple can be stored indefinitely in a Schlenk tube under N₂.

1,2-Dimethylcyclotetradecene;²⁰ Typical Procedure

TiCl₃ (DME)₂ (5.3 g, 15.7 mmol) and Zn-Cu couple (3.1 g, 47.6 mmol) were placed in a dry Ar-filled flask, DME (150 mL) is added, and the mixture was refluxed for 5 h. 2,15-Hexadecanedione (0.50 g, 2.0 mmol) in dry DME (50 mL) is added by syringe pump over a period of 35 h while the reaction temperature is maintained at 80 °C. After addition is complete the mixture is stirred for an additional 8 h. The mixture is cooled to r.t. and pentane (150 mL) added, the mixture is filtered through Florisil and concentrated under reduced pressure to give 1,2-dimethylcyclotetradecene as a mixture of *E/Z* isomers (92:8); yield: 360 mg (82%).

¹³C-NMR (*E*-isomer): $\delta = 18.4, 24.1, 25.3, 25.5, 26.3, 27.4, 33.5, 128.5$.

Intramolecular coupling has been widely used for the synthesis of compounds with unusual new structures (Table 7) and natural products (Table 8). Low-valent titanium coupling of the 4,10-dioxobicyclo [5.5.0] dodeca-1(7)ene (**54**) failed to give the novel compound **55**, since further rearrangement is too fast.⁸⁰

In the synthesis of natural products, low-valent titanium coupling has also been successfully used for the synthesis of the following compounds: hirsutene (TiCl₃/K, THF);⁸¹ bicyclogermacrene (TiCl₃/Zn-Cu, DME);⁸² lepidozene (TiCl₃/Zn-Cu, DME);⁸² compactin (TiCl₃/C₈K, DME);⁸³ cannithrene II (TiCl₃/Zn-Cu, THF);⁸⁴ the taxane skeleton (TiCl₃/Zn-Cu, DME);⁸⁵ isoamijol,⁸⁶ ceroplastol (TiCl₃/Zn-Cu, DME);⁸⁷ and strigol (TiCl₃/Zn-Cu, DME).⁸⁸ Selective coupling has also been

Table 7. Synthesis of Unusually Structured Compounds.

| Starting Material | Product | Reagent | Yield (%) | Ref. |
|--|---------|--|-----------|------|
| | | TiCl ₃ /K/DME | 13 | 90 |
| | | TiCl ₄ /Zn/pyridine/ THF | 40 | 91 |
| | | TiCl ₄ /Zn/THF | 95 | 92 |
| | | TiCl ₄ /Zn/dioxane | 90 | 93 |
| <i>n</i> = 1, 2 | | | | |
| | | TiCl ₃ /Li/DME | 56 | 94 |
| | | TiCl ₃ /LiAlH ₄ / DME | 35 | 95 |
| | | TiCl ₃ /LiAlH ₄ / THF | 77 | 96 |
| | | TiCl ₃ /LiAlH ₄ / THF | 35 | 97 |
| | | TiCl ₄ /Zn/THF | 32 | 98 |
| | | TiCl ₃ /LiAlH ₄ / THF | 14 | 99 |
| | | TiCl ₃ /LiAlH ₄ / THF | 32 | 99 |
| | | TiCl ₃ /Zn-Cu/ DME | 24 | 100 |
| | | TiCl ₃ /Zn-Cu/ DME | 90 | 101 |
| | | TiCl ₃ /Zn-Cu/ DME | 82 | 102 |
| | | TiCl ₄ /Zn/pyridine/ THF | 2-10 | 103 |
| <i>R</i> = CH ₃ , C ₂ H ₅ , <i>n</i> -C ₃ H ₇ | | | | |
| | | TiCl ₄ /Zn/pyridine/ THF | 16 | 104 |

applied to the synthesis of estrone;⁸⁹ intramolecular coupling of the aldehyde group in the intermediate **56** occurs faster at the ketone group in the tetralone moiety, than with the cyclopentanone moiety, to give **57**.

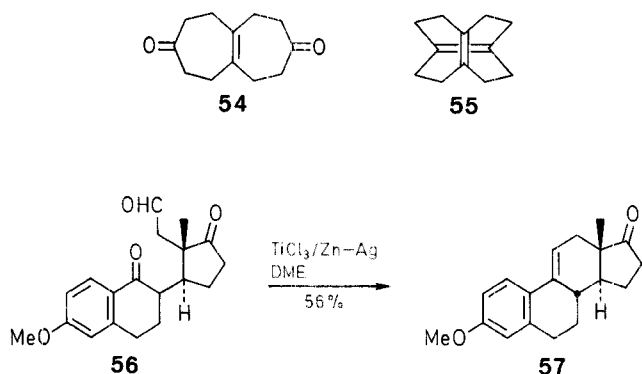

Intramolecular coupling of keto esters to give cyclic ketones has not been frequently applied compared to dicarbonyl coupling of aldehydes or ketones.^{5,77} Cyclic coupling of keto esters **58** yields cyclic ketones **59** ($n = 3-8$), whilst bicyclic ketones **61** can be synthesized from the cyclohexanone derivatives **60** ($R = H$, $n = 2-6$, 11 ; $R = t-C_4H_9$, $n = 1$).

The key step in the total synthesis of γ -caryophyllene is the intramolecular coupling of the keto ester **62** to give the ketone **63**, which is further methylated.¹¹² This is the only example of a double bond *E/Z* isomerization by low-valent titanium.

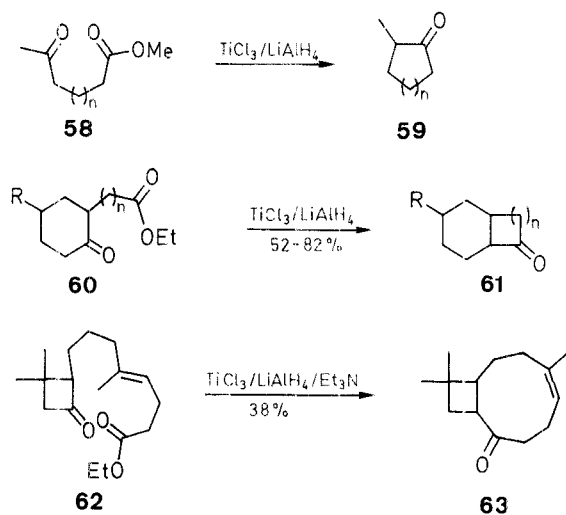

Table 8. Synthesis of Natural Products

| Starting Material | Product | Yield (%) | Ref. |
|-------------------|---------|-----------------|------|
| | | 57 ^a | 105 |
| | | 7 ^a | 106 |
| | | 60 ^a | 107 |
| | | 60 ^a | 108 |
| | | 58 ^a | 82 |
| | | 78 ^a | 109 |
| | | 32 ^a | 110 |
| | | 67 ^b | 111 |

^a Reagent: $TiCl_3/Zn-Cu/DME$.

^b Reagent: $TiCl_3/Zn/THF$.

4.2. Preparation of Cyclic Diols

The reaction of α,ω -dialdehydes **64** ($n = 1, 3, 5, 7, 9$) with low-valent titanium can be used for synthesis of cyclic di-*sec*-diols **64** in good yields.¹¹⁰ The *cis/trans* ratio of the cyclic glycols is dependent upon the ring size.

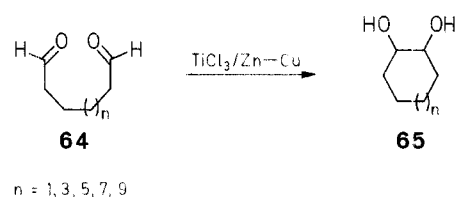

Two further intramolecular coupling reactions should be mentioned, the formation of the tricyclic diols **67**¹⁶ and **69**¹¹³ from **66** and **68**, respectively.

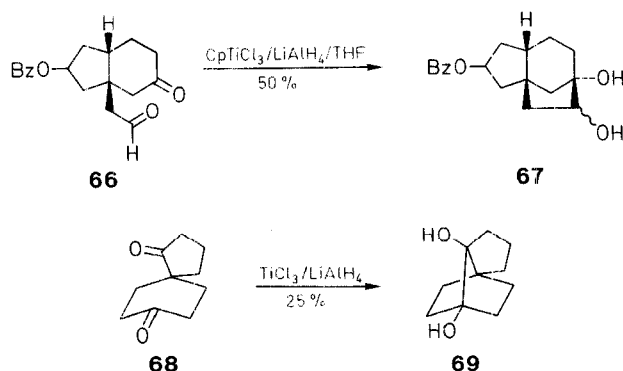

5. Reductive Eliminations

5.1. Deoxygenation of Glycols

Glycols can be deoxygenated by low-valent titanium species, some stereoselectivity is observed; for example, in the deoxygenation of *meso*- and *d,l*-5,6-decadiols (**70**) to isomeric 5-decenes **71**.⁴

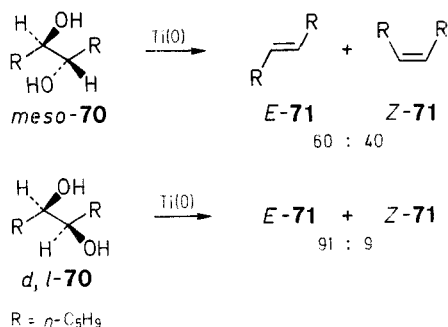

Polycyclic 1,2-diols can only be deoxygenated if the hydroxy groups are as *cis*-oriented, binding together to a common titanium metal surface (see Scheme E). *cis*-9,10-Decalindiol (**72**) is deoxygenated to 9,10-decalene (**73**), the *trans*-isomer is completely inert to deoxygenation by low-valent titanium.⁴

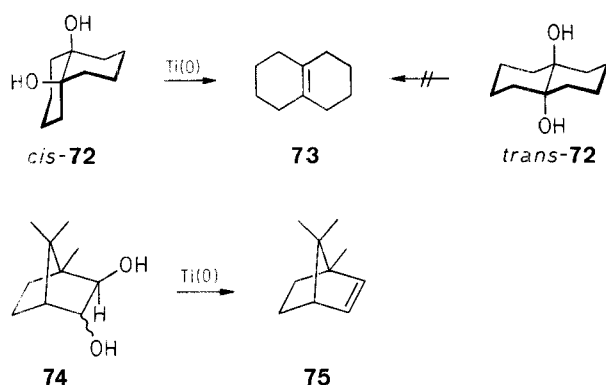

Scheme E

1,2-Adamantandiol is not deoxygenated by low-valent titanium, even though both hydroxy groups can bind to a common metal surface.^{4,42} Deoxygenation would yield the highly strained adamantene, which would be energetically unfavorable. Both isomeric 2,3-hydroxybornanes **74** are deoxygenated to the olefin norbornene (**75**) with low-valent titanium.⁴

5.2. Reductive Elimination of Other Groups

Several functional groups can be successfully subjected to reductive elimination by low-valent titanium species. Oxiranes, for example stilbene oxide (**76**)¹¹⁴ and 1,2-epoxycyclohexane (**77**), are reduced to the corresponding alkenes with moderate yields. Low-valent titanium species generated from titanocene dichloride/magnesium can be used for the deoxygenation of oxiranes with high selectivity (in the presence of ester groups) and stereoselectivity (with retention of configuration) in high yield (~90%).¹¹⁵ The bromohydrin *trans*-2-bromo-1-hydroxycyclooctane (**78**) is converted to cyclooctene in 96% yield by low-valent titanium.²⁵ This reaction has been applied to a number of bromohydrins, which were converted to the corresponding alkenes.²⁵

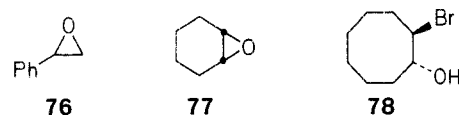

Cyclic *endo*-peroxides, for example **79**, give 1,3-dienes on treatment with low-valent titanium.¹¹⁶

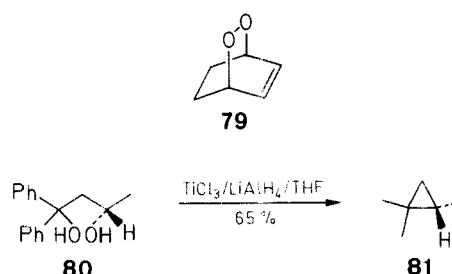

1,3-Alkanediols, such as **80** yield the 1,3-coupled product **81** with inverted configuration.¹¹⁷

Diallylic 1,4-diols, for example **82** (and its *cis*-isomer), yield 1,3-dienes on treatment with low-valent titanium.¹¹⁷

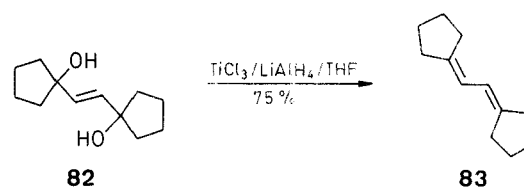

N-Hydroxyamines **84** are deoxygenated with low-valent titanium to give enamines **85**.¹¹⁸ Aromatic nitro compounds give the corresponding coupled azo compounds in good yield.⁴⁴

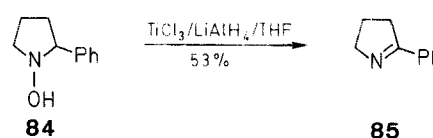

Synthesis of novel benzenoid molecules by low-valent titanium deoxygenation should be mentioned.¹¹⁹

6. Alkylidenation of Carbonyl Groups

6.1. Methylenations

Carbonyl groups of aldehydes, ketones, esters, amides, and acyl amides **86** can be efficiently methylenated to compounds **87** with dicyclopentadienyl titanium methylene complex (Tebbe reagent).^{120,121} This is prepared from the reaction of two equivalents of trimethylaluminum with dicyclopentadienyltitanium(IV) dichloride.¹²¹ An alternative more convenient method developed by Grubbs¹²² uses TiCl₃/Zn/CH₂Cl₂.

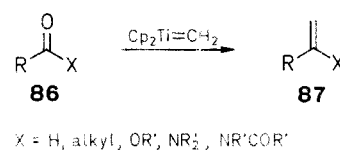

X = H, alkyl, OR', NR'₂, NR'COR'

The reaction is synthetically useful for the methylation of hindered or base sensitive ketones and offers advantages over the classical Wittig reaction. Keto esters can be selectively methylated at the keto group.

The dicyclopentadienyltitanium-methylene complex can be regarded as the Lewis acid part of the Lewis acid–base complex first formed from the reagents (Scheme F).¹⁸

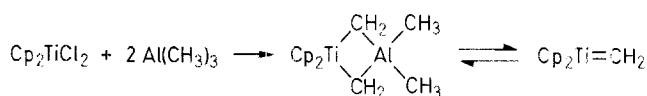

Scheme F

The complex is a Schrock-type, with a 16e configuration.¹³ Its polarization results in an electrophilic metallic centre and a nucleophilic carbon centre. The same complex can also be formed from titanacyclobutanes (Scheme F).¹²⁰

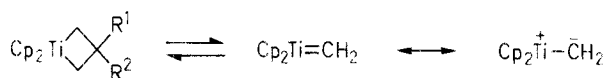

Scheme G

The reaction proceeds by a mechanism analogous to that of the Wittig reaction leading to an oxatitanacyclobutane derivative, which undergoes cycloreversion to give the methylene compound (Scheme H).

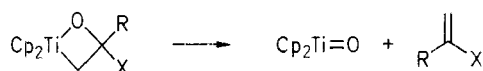

Scheme H

Five typical examples of the methylenation of esters and lactones are summarized in Table 9. Entries 1–4 were performed with Tebbe's reagent,¹²¹ the methylenation of the cyclic carbonate leading to the ketene acetal (entry 5) with Grubbs' reagent (dicyclopentadienyltitanacyclobutane).¹²² The use of the latter is strongly recommended if Lewis acid labile starting materials or products are used. No racemization of chiral products is observed with this reagent.

Table 9. Methylenations of Esters and Lactones

| Entry | Starting Material | Product | Yield (%) | Ref. |
|-------|-------------------|---------|-----------|------|
| 1 | | | 89 | 121 |
| 2 | | | 96 | 121 |
| 3 | | | 87 | 121 |
| 4 | | | 81 | 121 |
| 5 | | | 56 | 122 |

Preparation of Tebbe's Reagent:¹²¹

Neat AlMe_3 (42 mL, 0.2 mol) is added via canula to a suspension of dicyclopentadienyltitanium dichloride (50 g, 0.2 mol) in toluene (200 mL) under a dry N_2 -atmosphere with exclusion of moisture. Evolution of CH_4 starts immediately. The red solution is stirred for 48 h, while all volatiles are removed by vacuum distillation into a cold trap (Caution: all aluminum alkyls react violently with protic media!).

To the red precipitate is added an equimolecular amount of AlMe_3 (42 mL) in toluene (100 mL). The resulting solution is filtered through a pad of Celite supported on a coarse frit and concentrated to the point of saturation (~ 160 mL total volume). The saturated solution is carefully layered with an equal volume of hexane and allowed to stand undisturbed at -20° for 2–3 days. The supernatant is removed *via* cannula and the red crystalline mass is washed with petroleum ether (bp 60°C) at -20° (3×10 mL). The solids are dried under high vacuum. Yields are in the range of 30–35 g (53–61%).

Methylenation of Carbonyl Compounds; General Procedure:¹²¹ To a solution of the carbonyl compound (1 mmol) in THF (3 mL) is added Tebbe complex (0.5 M) in toluene (2 mL). After 30 min Et_2O (ca. 10 mL) is added, and then 0.1 M aq. NaOH (10 drops) is slowly added to destroy the active aluminum compounds. The deep red reaction mixture is dried (Na_2SO_4) filtered, through Celite and concentrated *in vacuo*. The crude product is purified by chromatography on basic alumina cluting with 2–5% Et_2O in pentane.

Vinyl enol ethers can be prepared from esters, amides are converted to enamines.¹²³ Acid chlorides and anhydrides are converted into titanium enolate complexes which react further by aldol-type chemistry.¹²⁴ The reaction of phenylacetyl chloride (**88**) with the Tebbe reagent forms the titanium enolate **89** which reacts with benzaldehyde to give the β -hydroxy ketone **90**.¹²⁴

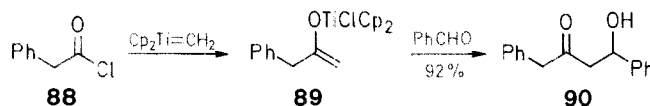

This reaction has found a broad application in organic synthesis, including synthesis of natural products, which cannot be covered here in detail.¹²⁵ A typical example is the synthesis of (\pm)-*A*^{9,12}-cappellene (**96**) via the adducts **91**, **92**.¹²⁶

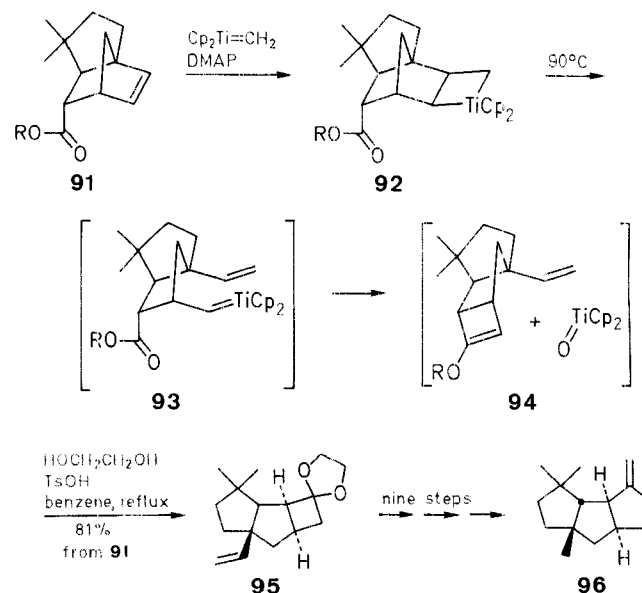

The preparation of substituted allenes **99** by reaction of an allene **97** with a ketone **98** in the presence of Grubbs' reagent has proved to be a very useful synthetic method (Table 10).¹²⁷

Table 10. Synthesis of Substituted Allenes **99** with Grubbs' Reagent

| 97 | R¹ | 98 | Yield (%) |
|-----------|----------------------|------------------|------------------|
| a | H | benzophenone | 58 |
| b | CH ₃ | 2-adamantanone | 75 |
| c | CH ₃ | 2-naphthaldehyde | 53 |
| d | Ph | cyclopentanone | 72 |

6.2. Alkylidenations

The low-valent titanium species prepared from the reaction of titanium tetrachloride and zinc does not only couple carbonyl compounds to alkenes and 1,2-diols; in the presence of 1,2-dihalo-1-alkenes, alkylidenation of the carbonyl group is observed.¹²⁶ Various esters **100** have been converted by this reagent into the corresponding alkenyl ethers **101** with high *Z*-selectivity Table 11.¹²⁸

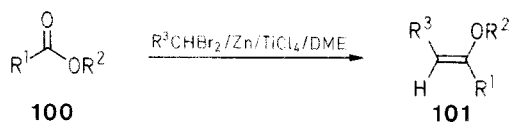

5-Methoxyundecene; Typical Procedure:¹²⁹

A solution of TiCl₄ (1.0 M, 4.0 mmol) in CH₂Cl₂ is added at 0° to THF (10 mL) under Ar. To the yellow solution at 25° is added TMEDA (1.2 mL, 8.0 mmol) and the mixture is stirred at 25° for 10 min. Zn dust (0.59 g, 9.0 mmol) is added to the mixture. The color of the suspension turns from brownish-yellow to dark greenish-blue in a slightly exothermic process. The mixture is stirred at 25° for 30 min, a solution of methyl pentanoate (0.12 g, 1.0 mmol) and 1,1-dibromohexane (0.54 g, 2.2 mmol) in THF (2 mL) is added to the mixture. The color of the resulting mixture gradually turns dark brown while being stirred at 25° for 2 h. The mixture is cooled to 0°C and sat. aq. K₂CO₃ (1.3 mL) is added. The mixture is stirred at 0° for another 15 min, and then diluted with Et₂O and passed rapidly through a short column of basic alumina (activity III) eluting with Et₂O/Et₃N (200:1, 100 mL). The resulting clear solution is concentrated and the residue is purified by column chromatography on basic alumina (activity III) eluting with pentane to give the desired 5-methoxy-undecene; yield: 0.18 g (96%), *Z/E* = 91:9.

Table 11. Alkylidenation of Esters **100** to Enol Ethers **101**

| R¹ | R² | R³ | Time (h) | Yield (%) | Ratio <i>Z/E</i> |
|--|---|---|-----------------|------------------|-------------------------|
| Ph | Me | CH ₃ | 2 | 86 | 92 : 8 |
| Ph | Me | CH ₂ CH(CH ₃) ₂ | 2 | 79 | 96 : 4 |
| CH ₃ | (CH ₂) ₇ CH ₃ | CH ₃ | 3 | 68 | 94 : 6 |
| (CH ₂) ₈ CH=CH ₂ | Me | CH ₃ | 3 | 53 | 89 : 11 |
| (CH ₂) ₇ CH ₃ | CH ₂ CH=CH(C ₃ H ₇) | CH ₃ | 3 | 85 | 94 : 6 |
| CH ₂ CH(CH ₃) ₂ | Me | (CH ₂) ₄ CH ₃ | 2 | 88 | 92 : 8 |
| (CH ₂) ₃ CH ₃ | Me | (CH ₂) ₄ CH ₃ | 2 | 96 | 91 : 9 |

7. Conclusions and Summary

The reductive coupling of aldehydes and ketones by low-valent titanium species (McMurry reaction) has greatly extended the standard potential of the olefin synthesis. In general, symmetrical 1,2-dialkyl-, tetraalkyl- and tetraarylethylenes are obtained in good to excellent yields. Synthesis of some unsymmetrical olefins has been achieved by mixed coupling. Mostly stereoselectivity cannot be controlled, similar to other olefin syntheses. The preparation of many new highly crowded ethylenes and stilbenes has been accomplished by this method. But neither di-*tert*-butyl nor *tert*-butyl isopropyl ketone can be coupled showing the steric limitation of the reaction.

Intramolecular coupling is also possible, allowing the preparation of several new unusually structured cyclic compounds as well as a great variety of natural products. The reaction can also be performed in the presence of some other reducible moieties like halogen, methoxycarbonyl and sulfonyl groups. Using special conditions glycols, which are formed as primary products of the coupling reaction, can be prepared. The titanium methylene complexes discovered recently by Tebbe and by Grubbs are synthetically useful for methylenations of various carbonyl groups, including esters and other carboxylic acid derivatives, extending the potential of the Wittig reaction.

Low-valent titanium species are also very versatile reagents for syntheses of glycols; the alternate reagents like low-valent vanadium,^{7,130} samarium¹³¹ and zinc-copper in the presence of ultrasonic treatment¹³² have only been applied in more special cases.

Addendum. I would like to thank Prof. J.E. McMurry for valuable discussions and an exchange of information. A review written by Prof. J.E. McMurry about the same topic will appear shortly in Chem. Rev.

Received: 29 March 1989; revised: 29 August 1989

- (1) Tyrlik, S., Wolochowicz, I. *Bull. Soc. Chim. Fr.* **1973**, 2147.
 - (2) Mukaiyama, T., Sato, T., Hanna, J. *Chem. Lett.* **1973**, 1041.
 - (3) McMurry, J.E., Fleming, M.P. *J. Am. Chem. Soc.* **1974**, *96*, 4708.
 - (4) McMurry, J.E., Fleming, M.P. *J. Org. Chem.* **1976**, *41*, 896; McMurry, J.E., Fleming, M.P., Kees, K.L., Krepski, L.R. *J. Org. Chem.* **1978**, *43*, 3255.
 - (5) McMurry, J.E. *Acc. Chem. Res.* **1983**, *16*, 405.
 - (6) Lenoir, D. *Synthesis* **1977**, 553.
 - (7) Lai, Y.-H. *Org. Prep. Proced.* **1980**, *12*, 361.
 - (8) Welzel, P. *Nachr. Chem. Tech. Lab.* **1983**, *31*, 814.
 - (9) Auderset, P.C., Gartenmann, T.C.C., Gesing, E.R.F. *Kontakte (Darmstadt)* **1985**, *3*, 14.
- Dang, Y., Geise, H.J. *Janssen Chimica Acta* **1989**, vol. 6, no. 3, 3.

- (10) Dams, R., Malinowski, M., Geise, H.J. *Bull. Soc. Chim. Belges* **1981**, 90, 1141.
Dams, R., Malinowski, M., Westdorp, I., Geise, H.J. *J. Org. Chem.* **1982**, 47, 248.
Dams, R., Malinowski, M., Geise, H.J. *Transition Met. Chem.* **1982**, 7, 37.
- (11) Hünig, S., Ort, B. *Liebigs Ann. Chem.* **1984**, 1905.
- (12) Fürstner, A., Weidmann, H. *Synthesis* **1987**, 1071.
- (13) Marshall, J.A., Bierenbaum, R., Chung, K.H. *Tetrahedron Lett.* **1979**, 2081.
- (14) Rieke, R.D. *Top. Curr. Chem.* **1975**, 59, 1.
Kahn, B.E., Rieke, R.D. *Chem. Rev.* **1988**, 88, 733.
- (15) Ghireghelli, D. *Tetrahedron Lett.* **1983**, 24, 287.
- (16) Corey, E.J., Danheiser, Chandrasekaran. *S. J. Org. Chem.* **1976**, 41, 260.
- (17) Ishida, A., Mukaiyama, T. *Chem. Lett.* **1976**, 1127.
- (18) Brown-Wensley, K.A., Buchwald, S.L., Cannizzo, L., Clowson, L., Ho, S., Meinhardt, D., Stille, J.R., Straus, D., Grubbs, R.H. *Pure and Appl. Chem.* **1983**, 55, 1733.
- (19) Sato, F. *J. Organomet. Chem.* **1985**, 285, 53.
- (20) McMurry, J.E., Lectka, T., Rico, J.G. *J. Org. Chem.* **1989**, 54, 3748.
- (21) Gapshi, G., Kini, A., Lin, R.S.H. *Chem. Lett.* **1978**, 803.
- (22) Jung, M.E., Lin, C.Y. *J. Org. Chem.* **1986**, 51, 5446.
- (23) Lenoir, D., Frank, R.M. *Tetrahedron Lett.* **1979**, 505.
Lenoir, D., Frank, R.M., Cordt, F., Gieren, A., Lamm, V. *Chem. Ber.* **1980**, 113, 739.
- (24) Villasenor, R.S., Johnson, C.R. *Org. Synth.* **1981**, 60, 113.
- (25) Olah, G.A., Prakash, G.K.S. *Synthesis* **1976**, 607;
Olah, G.A., Prakash, G.K.S., Liang, G. *Synthesis* **1976**, 319.
- (26) Timberlake, J.W., Inn, Y.M. *J. Org. Chem.* **1979**, 44, 4729.
- (27) Wenek, H., de Meijere, A., Gerson, F., Gleiter, R. *Angew. Chem. Int. Ed. Engl.* **1986**, 25, 335.
- (28) Langler, R.F., Tidwell, T.T. *Tetrahedron Lett.* **1975**, 775.
- (29) Bomse, D.S., Morton, T.H. *Tetrahedron Lett.* **1975**, 781.
- (30) Olah, G.A., Prakash, G.K.S. *J. Org. Chem.* **1977**, 42, 582.
- (31) Lenoir, D. *Chem. Ber.* **1978**, 111, 411.
- (32) Gano, J.E., Lenoir, D., Park, B.S., Roesner, R.A. *J. Org. Chem.* **1987**, 52.
- (33) Lenoir, D., Malwitz, D., Meyer, B. *Tetrahedron Lett.* **1984**, 25, 2965.
- (34) Böhner, G., Knorr, R. *Tetrahedron Lett.* **1984**, 25, 3675.
- (35) Roth, W., Lenoir, D., unpublished results.
- (36) Lenoir, D., Burghard, H. *J. Chem. Res. (S)*, **1980**, 396. (M), 4715.
- (37) McMurry, J.E. personal communication.
- (38) Lemmer, J., Weyerstahl, P. *Chem. Ber.* **1982**, 115, 3697.
- (39) Lemmen, P. unpublished results.
- (40) Bottino, F.A., Finocchiaro, P., Libertini, E., Reale, A., Recca, A. *J. Chem. Soc., Perkin Trans. 2* **1982**, 77.
- (41) Gano, J.E., Lenoir, D., Park, B.S., Pinkerton, A.A. to be published
Lenoir, D., Gano, J.E., McTague, J. *Tetrahedron Lett.* **1986**, 27, 5339.
- (42) Lenoir, D. unpublished results.
- (43) Newkome, G.R., Roper, J.M. *J. Org. Chem.* **1979**, 44, 502.
- (44) Willem, R., Pepermann, H., Halenga, K., Gielen, M., Dams, R., Geise, H.J. *J. Org. Chem.* **1983**, 48, 1980.
- (45) Agranat, I., Suissa, M.R., Cohen, S., Isaksson, R., Sandström, J., Dale, J., Grace, D. *J. Chem. Soc., Chem. Commun.* **1987**, 381.
- (46) Lenoir, D., Lemmen, P. unpublished results.
Lenoir, D., Lemmen, P. *Chem. Ber.* **1980**, 113, 3112.
Lemmen, P., Lenoir, D. *Chem. Ber.* **1984**, 117, 2300.
- (47) Gano, J.E., Park, B.S., Pinkerton, A.A., Lenoir, D. *J. Org. Chem.*, in press.
- (48) McMurry, J.E., Krepski, L.R. *J. Org. Chem.* **1976**, 41, 3929.
- (49) Doering, W.v.E., Roth, W.R., Bauer, F., Breuckmann, R., Ebbrecht, T., Herbolc, M., Lennartz, H.-W., Lenoir, D., Böse, R. *Chem. Ber.* **1989**, 122, 1263.
- (50) Hopf, H., El-Tamany, S., Raulfs, F.-W. *Angew. Chem. Int. Ed. Engl.* **1983**, 22, 633.
- (51) Reddy, S.M., Duraisamy, M., Walborsky, H.M. *J. Org. Chem.* **1986**, 51, 2361.
- (52) Paquette, L.A., Yan, T.-H., Wells, G.J. *J. Org. Chem.* **1984**, 49, 3610.
- (53) Coe, P.L., Criven, C.E. *J. Chem. Soc. Perkin I* **1986**, 475.
- (54) Beck, T.G., Barton, D.H.R., Britten-Kelley, M.R., Gusic, F.S.Jr. *J. Chem. Soc. Perkin Trans. I* **1976**, 19, 2079.
- Buter, J., Wassenar, S., Kellogg, R.M. *J. Org. Chem.* **1972**, 37, 4045.
- (55) Krebs, A., Rüger, W., Nickel, W.-U., Wilke, M., Burkert, U. *Chem. Ber.* **1984**, 117, 310; and references cited therein.
- (56) Cordt, F., Frank, R.M., Lenoir, D. *Tetrahedron Lett.* **1979**, 505.
- (57) Krebs, A., Kaletta, B., Nickel, W.-U., Rüger, W., Tikwe, L. *Tetrahedron* **1986**, 42, 1693.
- (58) Roth, W.R., private communication.
Herbold, M. *Dissertation*, University Bochum, 1989.
- (59) Gano, J.E., Wettach, R.H., Platz, M.S., Senthilnathan, V.P. *J. Am. Chem. Soc.* **1982**, 104, 2336.
- (60) Zimmerman, H.E., Dodd, J.R. *J. Am. Chem. Soc.* **1970**, 92, 6507.
- (61) Wong, C.S., Leung, W.S., Yeung, L.L., Luh, T.-Y. *J. Organomet. Chem.* **1986**, 307, C49.
- (62) Abruscato, G.J., Tidwell, T.T. *J. Am. Chem. Soc.* **1975**, 92, 4125.
Tidwell, T.T. *Tetrahedron* **1978**, 34, 1855.
- (63) Lenoir, D., Danner, H., Frank, R.M. *Chem. Ber.* **1980**, 113, 3112.
- (64) Olah, G.A., Wu, A.-h. Farooq, O. *J. Org. Chem.* **1989**, 54, 1375.
- (65) Dormagen, W., Breitmaier, F. *Chem. Ber.* **1986**, 119, 1734.
- (66) Castedo, L., Saa, J.M., Suan, R., Tojo, G. *Tetrahedron Lett.* **1983**, 24, 5419.
- (67) Pattenden, G., Robertson, G.M. *Tetrahedron Lett.* **1986**, 27, 399.
- (68) Chen, T.L., Chan, T.H., Shaver, A. *J. Organometal. Chem.* **1984**, 268, C1.
- (69) Richardson, W.H. *Syn. Commun.* **1981**, 11, 895.
- (70) Dams, R., Malinowski, M., Westdorp, I., Geise, H.J. *J. Org. Chem.* **1981**, 46, 2407.
Dams, R., Malinowsky, M., Geise, H.J. *Recl. Trav. Chim. Pays-Bas* **1982**, 101, 112.
- (71) Nakayama, J., Machida, H., Saito, R., Hoshino, M. *Tetrahedron Lett.* **1985**, 26, 1981.
- (72) Nakayama, J., Ikuina, Y., Murai, F., Hoshino, M. *J. Chem. Soc., Chem. Commun.* **1987**, 1072.
- (73) Seijas, J.A., deLera, A.R., Villaverde, M.C., Castedo, L. *J. Chem. Soc. Chem. Commun.* **1985**, 839.
- (74) Castedo, L., Saá, J.M., Suau, R., Tojo, G. *J. Org. Chem.* **1981**, 46, 4292.
- (75) Handa, Y., Inanaga, J. *Tetrahedron Lett.* **1987**, 28, 5717.
- (76) Betschart, C., Seebach, D. *Helv. Chim. Acta* **1987**, 70, 2215.
- (77) McMurry, J.E., Miller, D.D. *J. Am. Chem. Soc.* **1983**, 105, 1660.
- (78) Baumstark, A.L., McCloskey, C.J., Witt, K.E. *J. Org. Chem.* **1978**, 43, 3609.
- (79) McMurry, J.E., Kees, K.L. *J. Org. Chem.* **1977**, 42, 2655.
- (80) McMurry, J.E., Swenson, R. *Tetrahedron Lett.* **1987**, 28, 3209.
- (81) Disanayaka, B.W., Weedon, A.C. *J. Chem. Soc., Chem. Commun.* **1985**, 1282.
Disanayaka, B.W., Weedon, A.C. *J. Org. Chem.* **1987**, 52, 2905.
- (82) McMurry, J.E., Bosch, G.K. *Tetrahedron Lett.* **1985**, 26, 2167.
McMurry, J.E., Bosch, G.K. *J. Org. Chem.* **1987**, 52, 4885.
- (83) Clive, D.L., Murthy, K.S.K., Wee, A.G.H., Prasad, J.S., da Silva, G.V.J., Majewski, M., Anderson, P.C., Haugen, R.D., Heerze, L.D. *J. Am. Chem. Soc.* **1988**, 110, 69:4.
- (84) Ben, I., Castedo, L., Saa, J.M., Seijas, J.A., Suau, R., Tojo, G. *J. Org. Chem.* **1985**, 50, 2236.
- (85) Kende, A.S., Johnson, S., Sanfilippo, P., Hodges, J.C., Jungheim, L.N. *J. Am. Chem. Soc.* **1986**, 108, 3513.
- (86) Begley, M.J., Pattenden, G., Robertson, G.M. *J. Chem. Soc. Perkin I* **1988**, 1085.
- (87) Kato, N., Kataoka, H., Ohbuchi, S., Tanaka, S., Takeshita, H. *J. Chem. Soc., Chem. Commun.* **1988**, 354.
- (88) Berlage, U., Schmidt, J., Peters, U., Welzel, P. *Tetrahedron Lett.* **1987**, 28, 3091.
- (89) Ziegler, F.E., Lim, H. *J. Org. Chem.* **1982**, 47, 5229.
- (90) Paquette, L.A., Dressel, J., Pansegrau, P.D. *Tetrahedron Lett.* **1987**, 28, 4965.
- (91) Vogel, E., Püttmann, W., Duchatsch, W., Schieb, T., Schmickler, H., Lex, J. *Angew. Chem. Int. Ed. Engl.* **1986**, 25, 720.
- (92) Vogel, E., Neumann, B., Klug, W., Schmickler, H., Lex, J. *Angew. Chem. Int. Ed. Engl.* **1985**, 24, 1046.
- (93) Tirado-Rives, J., Oliver, M.A., Fronzek, F.R., Gandour, R.D. *J. Org. Chem.* **1984**, 49, 1627.
- (94) Marshall, J.A., Flynn, K.E. *J. Am. Chem. Soc.* **1984**, 106, 723.
For a review of betweenane synthesis, see Marshall, J.A. *Acc. Chem. Res.* **1980**, 13, 213.
- (95) Yamamoto, K., Harada, T., Nakazaki, M. *J. Am. Chem. Soc.* **1983**, 105, 7171.
Yamamoto, K., Harada, T., Okamoto, Y., Chikamatsu, H., Naka

- zaki, M., Kai, Y., Nakao, T., Tanaka, M., Harada, S., Kasai, N. *J. Am. Chem. Soc.* **1988**, *110*, 3578.
- (96) Janssen, J., Lüttke, W. *Chem. Ber.* **1982**, *115*, 1234.
- (97) Kasahara, K., Izumi, T., Shimizu, I., Satou, M., Katou, T. *Bull. Chem. Soc. Jpn.* **1982**, *55*, 2434.
- (98) Shimizu, I., Umezawa, H., Kanno, T., Izumi, T., Kasahara, A. *Bull. Chem. Soc. Jpn.* **1983**, *56*, 2023.
- (99) Shimizu, I., Kamei, Y., Tezuka, T., Izumi, T., Kasahara, A. *Bull. Chem. Soc. Jpn.* **1983**, *56*, 192, and references cited therein.
- (100) McMurry, J.E., Haley, G.J., Matz, J.R., Clardy, J.C., Van Duyne, G., Gleiter, R., Schäfer, W., White, D.H. *J. Am. Chem. Soc.* **1984**, *106*, 5018.
McMurry, J.E., Haley, G.J., Matz, J.R., Clardy, J.C., Van Duyne, G., Gleiter, R., Schäfer, W., White, D.H. *J. Am. Chem. Soc.* **1986**, *108*, 2932.
- (101) McMurry, J.E., Haley, G.J., Matz, J.R., Clardy, J.C., Mitchell, J. *J. Am. Chem. Soc.* **1986**, *108*, 515.
- (102) McMurry, J.E., Hodge, C.N. *J. Am. Chem. Soc.* **1984**, *106*, 6450.
- (103) Vogel, E., Sicken, M., Röhrig, P., Schmickler, H., Lex, J., Ermer, O. *Angew. Chem. Intl. Ed. Engl.* **1988**, *27*, 411.
- (104) Vogel, E., Balci, M., Pramod, K., Koch, P., Lex, J., Ermer, O. *Angew. Chem. Intl. Ed. Engl.* **1987**, *26*, 928 and references therein.
- (105) Wu, Y.-J., Burnell, D.J. *Tetrahedron Lett.* **1988**, *29*, 4369.
- (106) Jackson, C.B., Pattenden, G. *Tetrahedron Lett.* **1985**, *26*, 3393.
- (107) McMurry, J.E., Kocovsky, P. *Tetrahedron Lett.* **1985**, *26*, 2171.
- (108) McMurry, J.E., Matz, J.R. *Tetrahedron Lett.* **1982**, *23*, 2723.
- (109) McMurry, J.E., Matz, J.R., Kees, K.L., Bock, P.A. *Tetrahedron Lett.* **1982**, *23*, 1777.
McMurry, J.E., Matz, J.R., Kees, K.L. *Tetrahedron*, **1987**, *43*, 5489.
- (110) McMurry, J.E., Rico, J.G., personal communication.
- (111) Kato, N., Nakanishi, K., Takeshita, H. *Bull. Chem. Soc. Jpn.* **1986**, *59*, 1109.
- (112) McMurry, J.E., Miller, D.D. *Tetrahedron Lett.* **1983**, *24*, 1885.
- (113) Eaton, P.E., Jobe, P.G., Nyi, K. *J. Am. Chem. Soc.* **1980**, *102*, 6636.
- (114) Dams, R., Malinowski, M., Geise, H.J. *Recl. Trav. Chim. Pays. Bas* **1980**, *101*, 112.
McMurry, J.E., Silvestri, M.G., Fleming, M.P., Hoz, T., Grayston, M.W. *J. Org. Chem.* **1978**, *43*, 3249.
- (115) Schobert, R. *Angew. Chem. Int. Ed. Engl.* **1988**, *27*, 855.
- (116) Riguera, R., Quiñoá E., Castedo, L. *J. Chem. Soc. Chem. Commun.* **1984**, 1120.
- (117) Walborski, H.M., Murari, M.P. *J. Am. Chem. Soc.* **1980**, *102*, 426.
- (118) Walborski, H.M., Wüst, H.H. *J. Am. Chem. Soc.* **1982**, *104*, 5807.
- (119) Wong, H.N.C. *Acc. Chem. Res.* **1989**, *22*, 145.
- (120) Muraharshi, S.F., Kodera, Y. *Tetrahedron Lett.* **1985**, *26*, 4633.
- (121) Tebbe, F.N., Pashall, G.W., Reddy, G.S. *J. Am. Chem. Soc.* **1978**, *100*, 3611.
- (122) Anslyn, E.V., Grubbs, R.H. *J. Am. Chem. Soc.* **1987**, *109*, 4880.
- (123) Pine, R.H., Pettit, R.J., Geib, G.D., Cruz, S.G., Gallego, C.H., Tijerina, T., Pine, R.D. *J. Org. Chem.* **1985**, *50*, 1212.
- (124) Cannizo, L.F., Grubbs, R.H. *J. Org. Chem.* **1985**, *50*, 2316.
- (125) Reißig, H.-U. *Nachr. Chem. Techn. Lab.* **1986**, *34*, 562.
- (126) Stille, J.R., Grubbs, R.S. *J. Am. Chem. Soc.* **1986**, *108*, 855.
- (127) Buchwald, S.L., Grubbs, R.H. *J. Am. Chem. Soc.* **1983**, *105*, 5490.
- (128) Hibino, J.E., Okazoe, T., Takai, K., Nozaki, H. *Tetrahedron Lett.* **1980**, 5579.
- (129) Okazoe, T., Takai, K., Oshima, K., Utimoto, K. *J. Org. Chem.* **1987**, *52*, 4410.
- (130) Freudenberger, J.H., Konradi, A.W., Pedersen, S.F. *J. Am. Chem. Soc.* **1989**, *111*, 8014; and references cited therein.
- (131) Léonhard, E., Duñach, E., Périchon, J. *J. Chem. Soc., Chem. Commun.* **1989**, 276.
- (132) Delair, P., Luche, J.-L. *J. Chem. Soc., Chem. Commun.* **1989**, 389.