

The influence of different mixing methods on the dimensional stability and surface detail reproduction of two different brands of irreversible hydrocolloids

Ahmet Kursad Culhaoglu, Ali Zaimoglu, Evrim Dogan, Serhat Emre Ozkir¹

Department of Prosthodontics, Faculty of Dentistry, Kirikkale University, Kirikkale, ¹Department of Prosthodontics, Faculty of Dentistry, Afyon Kocatepe University, Afyonkarahisar, Turkey

Address for correspondence:

Dr. Ahmet Kursad Culhaoglu,
Private Practice, Doktor Mediha Eldem
Sokak, No: 70/11 Kocatepe,
Ankara, Turkey.
E-mail: ahmetculhaoglu@hotmail.com

ABSTRACT

Purpose: Irreversible hydrocolloid impression materials are some of the most common impression materials in dentistry. Preparation of alginate is critical for dental appliance fabricated upon the cast made directly from the impression. This study compared the effect of two mixing methods i.e. hand mixing or device mixing on the physical properties of two different brands of irreversible hydrocolloid. **Materials and Methods:** Two alginate impression materials: Cavex Tulip (Tulip, Cavex Holland BV, Haarlem, Holland) and Hydrogum Soft (Zhermack, Rovigo, Italy), were mixed according to manufacturers instructions with two mixing methods. Mixing was performed at room temperature using tap water. The material was allowed to set in a water bath at 35°C (±1°C), simulating intra-oral setting conditions. For each tested material, nine standardized samples were used. The first method was hand mixing; the other method was with a device. Detail reproduction and dimensional changes of impressions were compared. One-way analysis of variance was performed to compare the dimensional differences between the four groups. **Results:** The device mixed specimens showed better surface detail than hand-mixed samples. Cavex alginate demonstrated better surface detail than Hydrogum. Cavex Tulip alginate showed better dimensional stability than Hydrogum Soft in both hand-mixed and device-mixed samples. Furthermore, all device mixed samples were better than hand-mixed in terms of dimensional stability. A two-way analysis of variance and Fisher's protected least significant difference test at the 0.05 level of significance were used to analyze the data. **Conclusion:** Of the two mixing methods, the vacuum mixer had the best performance overall in reducing the number, percent and volume of porosities in the mixed alginate.

Key words

Dimensional stability, irreversible hydrocolloids, mixing type, surface detail

INTRODUCTION

Irreversible hydrocolloid materials have been widely used in prosthetic dentistry. Alginate impression materials were developed in the 1930s. For obtaining diagnostic and study models of partially or completely edentulous patients, for the impressions of the opposing archs and as the final impression material of certain completely edentulous patients, irreversible hydrocolloids are preferred by many clinicians because it is inexpensive, hydrophilic, reasonably accurate and too easy to manipulate.^[1,2]

Despite being widely accepted and used that alginate is not stable impression material for storage. Because of its limited storage time, dimensional stability of the set alginate is limited.^[3] When alginate impressions set, they become three-dimensional semi-permeable gels. Alginate impressions exhibit the two distinct processes of syneresis and imbibition. Free water is gradually extruded on the surface is termed syneresis. Alginates also prone to water absorption, termed imbibition.^[3]

Despite their lower physical properties compared with elastomeric impression materials, sufficient final impressions could be obtained by following appropriate mixing conditions. Air entrapments or porosities within the impression material may influence the accuracy of an impression and the resulting cast. Using mechanical mixing device can reduce the porosity.^[4,5]

Studies by previous writers much interested on the effects of disinfection, there are limited number of studies

Access this article online	
Quick Response Code:	Website: www.ejgd.org
	DOI: 10.4103/2278-9626.126204

reporting the effect of the mixing device on the irreversible hydrocolloid impressions. The aim of this study was to compare the effects of mixing methods i.e. hand mixing or device mixing on the various physical properties of different brands of irreversible hydrocolloids.

MATERIALS AND METHODS

A stainless steel test die was constructed according to American Dental Association specification no: 18 for alginate impression material^[6,7] [Figure 1]. The impression mould was lubricated with isolater (soft petroleum jelly). The block was cleaned with alcohol and allowed to air dry prior to recording each impression. Two alginate impression materials: Cavex Tulip (Tulip, Cavex Holland BV, Haarlem, Holland) and Hydrogum Soft (Zhermack, Rovigo, Italy), were mixed according to manufacturers introductions with two mixing methods. The first method was manual mixing, the other method was with an automatic mixing machine (Algimax, model DM 21, MonitexXianyang Holy Medical Co., Ltd. PRC) [Figure 2]. The mixed impression material was placed on the center of the molds surface. A glass plate was placed on the molds surface. The assembly was immediately transferred to a water bath at $35 \pm 2^\circ\text{C}$.

After the setting time that the manufacturer recommended mold was removed from test block surface. 18 Cavex alginate samples, 9 of which hand-mixed and 9 of machine-mixed and 18 Hydrogum alginate samples, 9 of which hand-mixed and 9 of which machined-mixed were subjected to investigation. A two-way analysis of variance and Fisher's protected least significant difference test at the 0.05 level of significance were used to analyze the data.

Detail reproduction of impressions

The impression material was mixed and applied carefully to the test die in order to minimize trapped air. The impressions surface was assessed visually for reproduction of the lines from the test block. The impressions were observed under low – angle illumination without magnification. For better discrimination between specimens, a scanning system with rating values from 1 to 4 was followed

- Rating 1: Well-defined, sharp detail, continuous line [Figure 3].
- Rating 2: Continuous line but with loss of sharpness [Figure 4].
- Rating 3: Poor detail or loss of continuity of the line [Figure 5].
- Rating 4: Marginally or not discernible.

Dimensional changes of impressions

The samples were photographed with Nikon Coolpix MDC Lens (Nikon Corp., Tokyo, Japan) combined to microscope and measured with Clemex image analyze program.

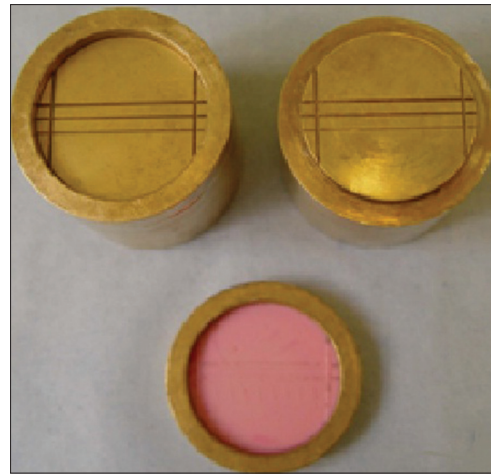

Figure 1: Stainless steel test die constructed according to American dental association specification no: 18 for alginate impression material



Figure 2: Automatic mixing machine Algimax, model DM 21

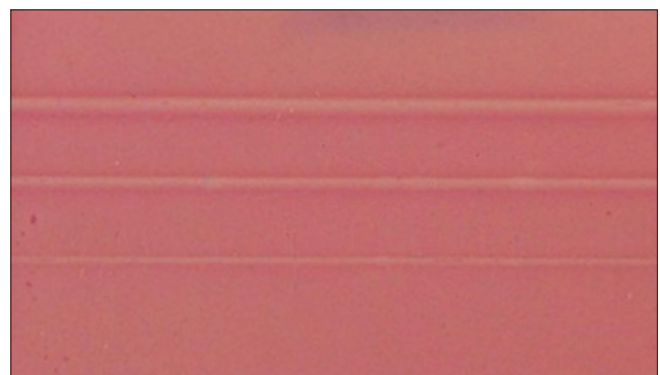

Figure 3: Rating 1: Well-defined, sharp detail, continuous line

The impressions were evaluated by measurement of the linear dimension of line X point from X' point. The percentage dimensional change of impressions were calculated by using the formula $(A-B/A) \times 100$, where A is the master model measurement and B is the experimental model measurement. The distance between the crosslines X-X' shown on Figure 6, measured to the

nearest 25 μm line on the impression surface using a measuring microscope (Nikon Optihot-100, Tokyo, Japan) [Figure 7]. The microscope was modified with a ring flash fixed at 1.5 inches from the stage to maintain uniform intensity of light. The measurement (X-X') of the metal die was calculated to 24.150 mm [Figure 6]. Figure 8 shows schematic drawing of stainless steel analog indicating the lines measured and reference points. Figure 9 shows microscobic image of alginate samples.

RESULTS

Detail reproduction of impressions

The surface quality of 36 models was fulfilled the relevant specitions in terms of reproduction of the appropriate lines. None of the specimens showed the rates 3 or 4. The detail reproduction of impressions was presented in [Figure 10]. The device mixed specimens showed better surface detail than hand-mixed samples. Cavex alginate demonstrated better surface detail than hydrogum.

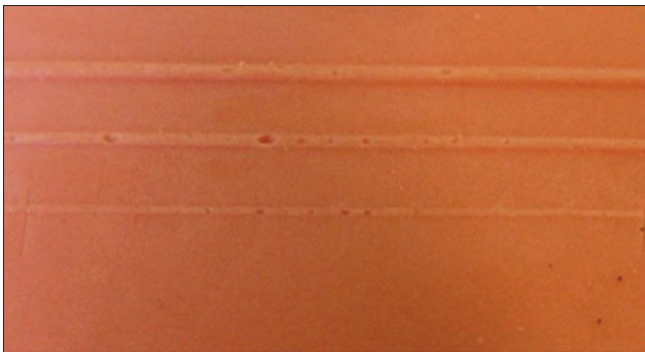

Figure 4: Rating 2: Continuous line but with loss of sharpness

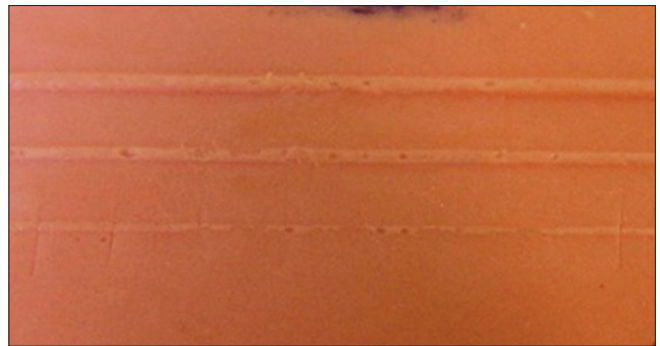

Figure 5: Rating 3: Poor detail or loss of continuity of the line

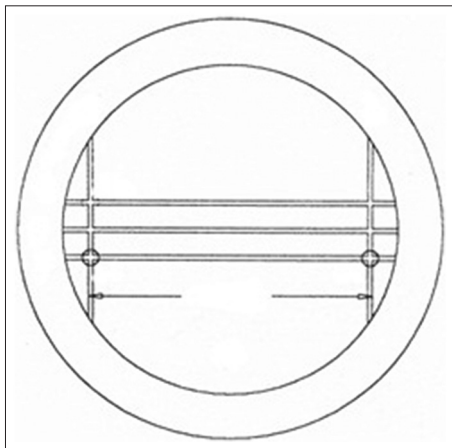

Figure 6: The distance between the crosslines X-X'



Figure 7: Measuring microscope (Nikon Optihot-100, Japan)

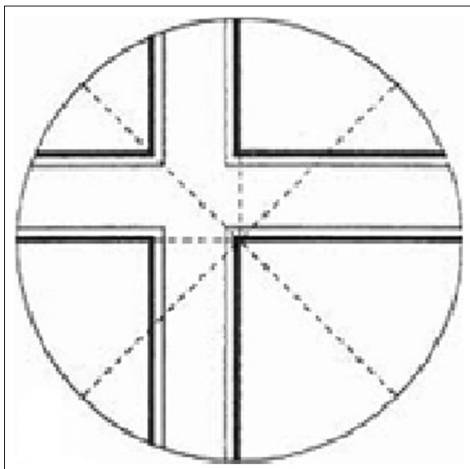

Figure 8: Schematic drawing of stainless steel analog

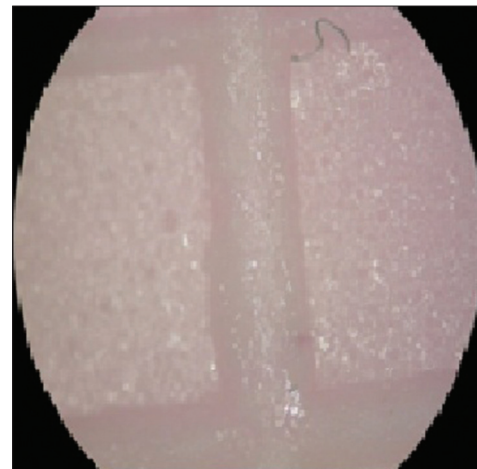

Figure 9: Microscobic image of alginate samples

Dimensional changes of impressions

The percentage dimensional changes of alginate samples from the metal die are presented in [Figure 11 and 12]. For instance, the two-way interaction between type of material and mixing technique implies that the difference between the materials depends on mixing technique. There was significant difference ($P > 0.05$) in overall dimensional accuracy between two brands of impression material used.

For Hydrogum Soft, hand mixed samples; the deviation was found to range from 0.66% to 1.25% and for Hydrogum Soft, device mixed was 0.053-0.894% [Figure 11].

For Cavex Tulip hand mixed samples; the deviation was found to range from 0.517% to 1.432% and for Cavex Tulip, device mixed was 0.03-0.621% [Figure 12].

One way analysis of variance was performed to compare the dimensional differences between the four groups. Cavex Tulip alginate showed better dimensional stability than Hydrogum Soft in both hand-mixed and device-mixed samples. Furthermore, all device mixed samples were better than hand-mixed in terms of dimensional stability and surface detail.

DISCUSSION

Koski compared mixing techniques and devices with different alginate brands and showed that alginate mixed with the vacuum mixer produced fewer surface defects and had better detail reproduction with cast gypsum than either hand or centrifugal mixing.^[8] Furthermore some other studies have shown that handmixing of elastomeric impression materials produced more porosities than automated-mixing.^[9,10] Inoue *et al.* reported that the high-speed rotary mixing instruments, such as the automatic instrument, greatly reduced the number of air bubbles with the paste.^[11] Furthermore it has been reported that there is no major difference in physical properties of alginates using either hand or mechanical mixing.^[12] The largest deviation in measurement between the test die and impressions was 1.432% at hand mixed impression. This level of deviation would have greater significance if the impressions were to be used construct fixed prostheses.

It was observed in this study that mechanical mixing improve the consistency of the alginate after mixing, the ease in which the material was incorporated into the mix, the bubble-free texture and the ease of use, when compared with hand mixing. The quality of impressions produced from. Cavex Tulip alginate, mixed with device was of a higher standard in terms of surface reproduction.

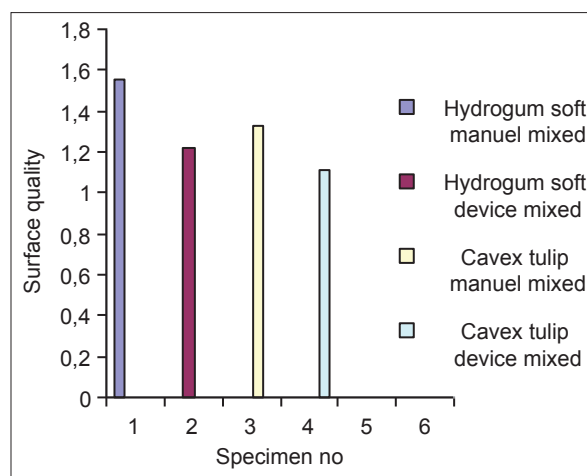

Figure 10: Detail reproduction of impressions

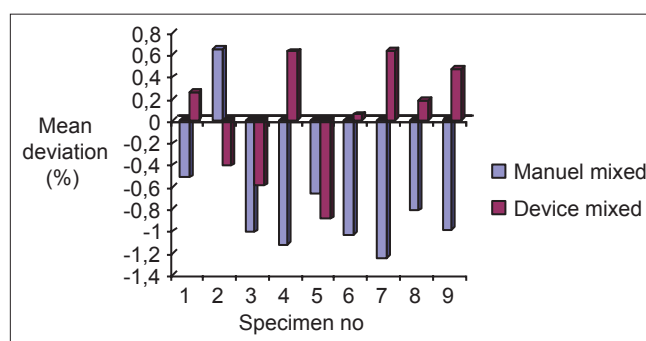

Figure 11: The percentage dimensional changes of Hydrogum soft alginate samples from the metal die

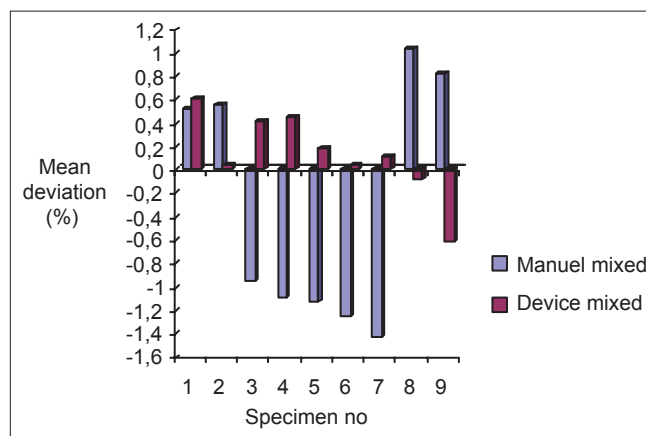

Figure 12: The percentage dimensional changes of Cavex tulip alginate samples from the metal die

Within the limitations of this *in vitro* study. The differences between the materials and between the mixing methods are found to be significant. The preference for device mixing is not only to standardize the alginate mixing procedure but also to facilitate the mixing, to reduce the amount of air bubbles, to obtain a homogenous mixture.^[13]

REFERENCES

1. al-Omari WM, Jones JC, Wood DJ. The effect of disinfecting alginate and addition cured silicone rubber impression materials on the physical properties of impressions and resultant casts. *Eur J Prosthodont Restor Dent* 1998;6:103-10.
2. Baxter RT, Lawson NC, Cakir D, Beck P, Ramp LC, Burgess JO. Evaluation of outgassing, tear strength, and detail reproduction in alginate substitute materials. *Oper Dent* 2012;37:540-7.
3. Boden J, Likeman P, Clark R. Some effects of disinfecting solutions on the properties of alginate impression material and dental stone. *Eur J Prosthodont Restor Dent* 2001;9:131-5.
4. Hamilton MJ, Vandewalle KS, Roberts HW, Hamilton GJ, Lien W. Microtomographic porosity determination in alginate mixed with various methods. *J Prosthodont* 2010;19:478-81.
5. Wandrekar S, Juszczak AS, Clark RK, Radford DR. Dimensional stability of newer alginate impression materials over seven days. *Eur J Prosthodont Restor Dent* 2010;18:163-70.
6. Petrie CS, Walker MP, O'mahony AM, Spencer P. Dimensional accuracy and surface detail reproduction of two hydrophilic vinyl polysiloxane impression materials tested under dry, moist, and wet conditions. *J Prosthet Dent* 2003;90:365-72.
7. Rios MP, Morgano SM, Stein RS, Rose L. Effects of chemical disinfectant solutions on the stability and accuracy of the dental impression complex. *J Prosthet Dent* 1996;76:356-62.
8. Koski RE. Comparative study of selected alginate materials and devices. *J Am Dent Assoc* 1977;94:713-6.
9. Soh G, Chong YH. Relationship of viscosity to porosities in automixed elastomeric impressions. *Clin Mater* 1991;7:23-6.
10. Chong YH, Soh G, Lim KC, Teo CS. Porosities in five automixed addition silicone elastomers. *Oper Dent* 1991;16:96-100.
11. Inoue K, Song YX, Kamiunten O, Oku J, Terao T, Fujii K. Effect of mixing method on rheological properties of alginate impression materials. *J Oral Rehabil* 2002;29:615-9.
12. Frey G, Lu H, Powers J. Effect of mixing methods on mechanical properties of alginate impression materials. *J Prosthodont* 2005;14:221-5.
13. Drecsen K, Kellens A, Wevers M, Pushpik JT, Willems G. The influence of mixing methods and disinfectant on the physical properties of alginate impression materials. *Eur J Orthod* 2012;10:1-7.

How to cite this article: Culhaoglu AK, Zaimoglu A, Dogan E, Ozkir SE. The influence of different mixing methods on the dimensional stability and surface detail reproduction of two different brands of irreversible hydrocolloids. *Eur J Gen Dent* 2014;3:17-21.
Source of Support: Nil, **Conflict of Interest:** None declared.

Author Help: Online submission of the manuscripts

Articles can be submitted online from <http://www.journalonweb.com>. For online submission, the articles should be prepared in two files (first page file and article file). Images should be submitted separately.

1) **First Page File:**

Prepare the title page, covering letter, acknowledgement etc. using a word processor program. All information related to your identity should be included here. Use text/rtf/doc/pdf files. Do not zip the files.

2) **Article File:**

The main text of the article, beginning with the Abstract to References (including tables) should be in this file. Do not include any information (such as acknowledgement, your names in page headers etc.) in this file. Use text/rtf/doc/pdf files. Do not zip the files. Limit the file size to 1 MB. Do not incorporate images in the file. If file size is large, graphs can be submitted separately as images, without their being incorporated in the article file. This will reduce the size of the file.

3) **Images:**

Submit good quality color images. Each image should be less than 4096 kb (4 MB) in size. The size of the image can be reduced by decreasing the actual height and width of the images (keep up to about 6 inches and up to about 1800 x 1200 pixels). JPEG is the most suitable file format. The image quality should be good enough to judge the scientific value of the image. For the purpose of printing, always retain a good quality, high resolution image. This high resolution image should be sent to the editorial office at the time of sending a revised article.

4) **Legends:**

Legends for the figures/images should be included at the end of the article file.